

# The Battle Station

A Navy Board Models

Modeling Project for Novice and Intermediate Model Builders



1:32 Scale

[www.navyboardmodels.com](http://www.navyboardmodels.com)

Navy Board Models is a member of the  
Model Ship Builder group of websites

[www.modelshipbuilder.com](http://www.modelshipbuilder.com)





## **The Battle Station**

A 3/8"=1' Scale Modeling Practicum  
Based on the Plans of J. Staudt

By Jeff Staudt  
jstaudt@modelshipbuilder.com

Edited by: W.E. Scoville  
winston@modelshipbuilder.com

© [www.navyboardmodels.com](http://www.navyboardmodels.com) / [www.modelshipbuilder.com](http://www.modelshipbuilder.com)

This Practicum may be re-distributed freely as long as it remains,  
whole, intact and un-altered.

Published by  
[www.modelshipbuilder.com](http://www.modelshipbuilder.com)

Photo Credits

Cover:  
Jeff Staudt

Internal:  
Jeff Staudt

### **How to Contact Model Ship Builder**

By email: [info@modelshipbuilder.com](mailto:info@modelshipbuilder.com)

By Snail-Mail

ModelShipBuilder.com  
c/o Winston Scoville  
2 St. Charles Place RR5  
Clinton, Ontario, N0M 1L0  
Canada



## Table of Contents

Part 1—Mounting Base, Lower Deck Clamp and Supports	4
Part 2—Frames and Upper Deck Clamp	6
Part 3—Lower Deck Framing and Deck Planking	9
Part 4—Lower Inside Spirketing, Waterway, and Gunport Ring Locations	11
Part 5—Top Deck Framing	13
Part 6—Outside Wales, Strakes and Gunwale	16
Part 7—Deck Details	18
Part 8—Gun Port Lids and Rigging	20
Part 9—The Final Stages—Gun Port Lids & Rigging and Accessories	23
Appendix A—Material List	29
Appendix B—The Drawings	31



## Part 1

### Mounting Base, Lower Deck Clamp and Supports

We will begin our build with the mounting base. When selecting wood for this you might want to think about how you intend to display your model. Here are a few examples to consider.

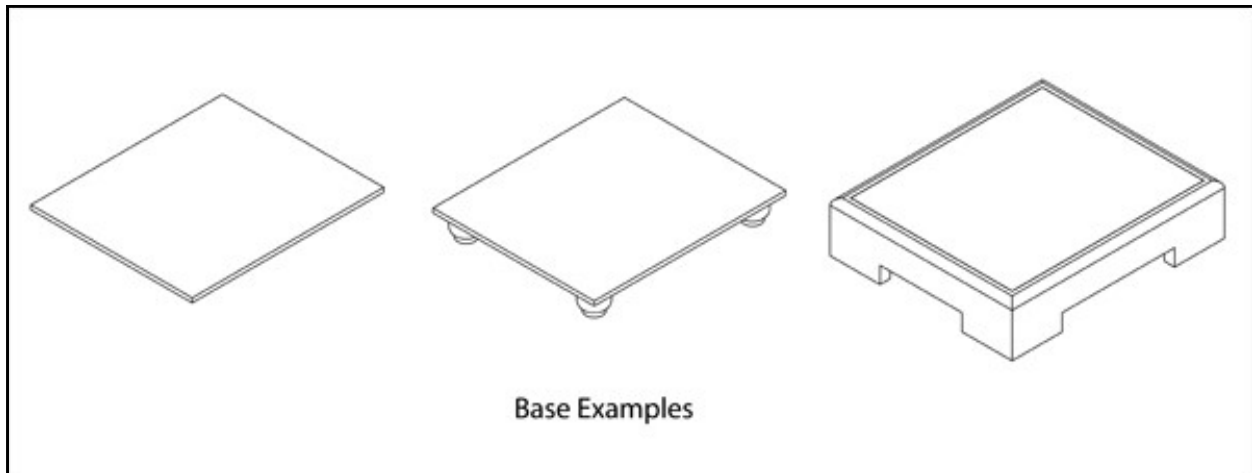

If you intend to use plywood I would suggest covering the edges with some type of trim or molding. A solid wood base should have nice finished edges already. Whatever you use make sure that the top surface has a good finish. In our final step of the build we will add these details to the mounting base.

Using pages 2 and 5 we will determine the overall size of the mounting base.

On page 5 measure the length of the lower deck beam. Add 2" - 1" reveal on both sides. This is the overall width of the base.

Next, go to page 2. Measure the distance from the outside edge of the lower wale to the outside edge of the support. Now add 2" - again, 1" reveal on both sides. This is the overall depth of the base.

Using the above information I've determined that at 1:32nd scale the mounting base is 11-9/16" in width by 9-5/8" in depth.

**IMPORTANT-** On page five the plans indicate a measurement of 6-15/16". This should be 6-7/8" instead. The above calculations reflect this correction.

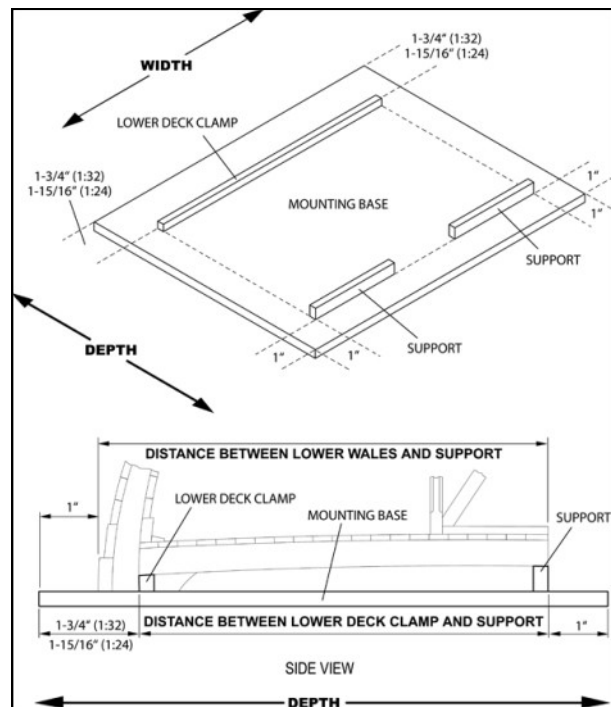



If for any reason your plans vary slightly from what I have indicated here, by all means use the measurements you come up with. The most critical dimension is the distance between the lower deck clamp and support.

Mark your measurement to the base and cut it out.

Now mark the base indicating the location of the lower deck clamp and supports. Keep in mind that the location of the outside edge of the lower deck clamp sets in further than an inch. This accommodates the thickness of the frame and lower wale.

Using the templates provided on page 5 cut out the upper and lower deck clamps, and supports. We won't be using the upper deck clamp yet, but now is good time to go ahead and get it ready.

Notice that the cross section shows that the deck clamps aren't rectangular, but have tapered edges. Mark and sand these surfaces to the profile shown as this will be important when assembling the frames the deck beams later.

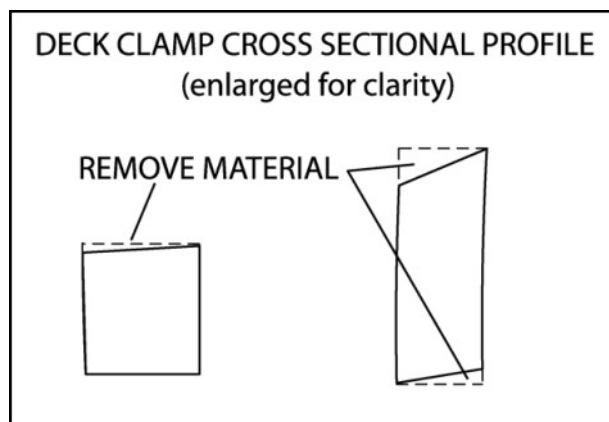

Glue the lower deck clamp and supports to the areas you marked on the base. Here's what we've accomplished so far:



In our next step we'll cut out the frames and attach them to the lower deck clamp, add the upper deck clamp, and treenail everything securely in place.



## Part 2 Frames and Upper Deck Clamp

In this step we are going to assemble the frames to the lower deck clamp and mounting base. Then we'll attach the upper deck clamp, and treenail everything.

Glue template parts A to G from page 7 of the plans to the wood that you have selected for this. Orient the templates on the wood in relationship to the grain pattern as shown below. Typically rubber cement or a re-positional spray mount works best. We're not looking for a permanent bond here, just something that holds well until we get the parts cut out and marked.

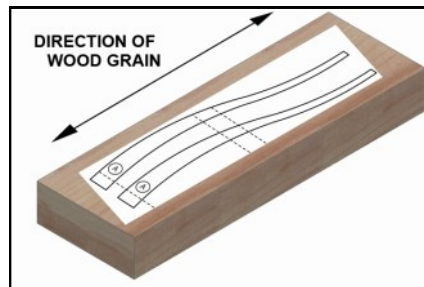

Now we're ready to cut out all of the pieces. It's best to stay slightly outside the lines.

After all of the pieces are cut, sand down the outside and inside surfaces to the lines for a good finished edge.



Using a pencil, transfer the lines indicating the upper deck clamp location along the inside edges of all the frame parts, with the exception of parts D and G. Now mark the location of the notches you will cut for the gunport sills. These frames will be cut in pairs: one set of frame F, and two sets of frame B. Notice that one set of the notches in the pair are cut on opposite sides of the frame.

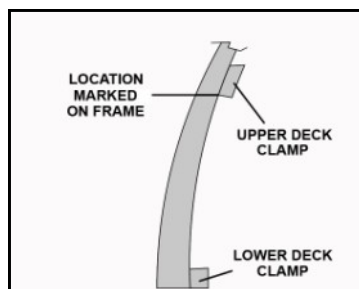

Depending on the scale of your build cut the notches 1/8" to 3/16" deep. For this step a small xacto style back saw works great. Now using a small knife or chisel carefully remove the portion you just cut. It should



be fairly easy because of the wood grain direction. Clean up all of the bottom edge until you have a nice square notch. Repeat this step for all of the remaining notched frames.

Cut the six gunport sills H to the length shown in the plans. Keep the width slightly wider than the frames. Glue the gunport sills to the frames allowing the sill to stand "proud" on both sides. After the glue has dried sand the gunport sill surfaces flush with the frames.

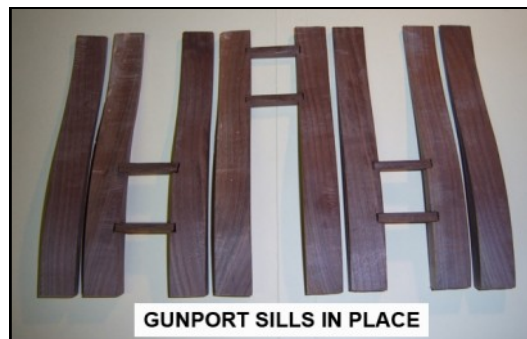

We are now ready to start gluing the frames to the base and lower deck clamp. Start by gluing one of the frame A's to the end of the clamp and resting on the base. Make sure this frame is perfectly square with the base, and clamp it in place. Allow this to dry before proceeding. Now, working across the length of the deck clamp repeat this process with the remaining frames. At 1:32 scale a 1/8" thick piece of wood works well for a spacer between each. The final step is gluing small frame pieces D, F and G in place.

Glue the upper deck clamp in place at the location you marked earlier. Clamp as needed till it dries.

## Treenailing

The final step is securing everything together well with wooden pegs known as treenails. For mine I'm using round toothpicks, mainly because I like the way they look after a finish is applied. Many builders prefer bamboo instead. Use what works best for you. Cut the treenails long enough to extend beyond the surfaces where they protrude.

At 1:32 scale I'm using a 1/16" drill bit for the treenail holes. Start by drilling a hole through the underside of the base into the bottom center of the each frame. Don't drill to deep, maybe 3/8". Now make a mark centered in the height of the deck clamps as well as centered on the width of each frame. At each location drill completely through the deck clamps and frames.

Using a small amount of glue, treenail all of the holes. This should be a good fit, but don't force them in place. Remove a small amount of material if necessary. Remember, if you break the treenail off in the frame by force then plan on going digging to get them out!



After everything is dry trim the treenails back and sand them flush to the base, frame, and clamp surfaces. The build is strong enough now to carefully do a good finish sanding of the inside and outside of the frames.

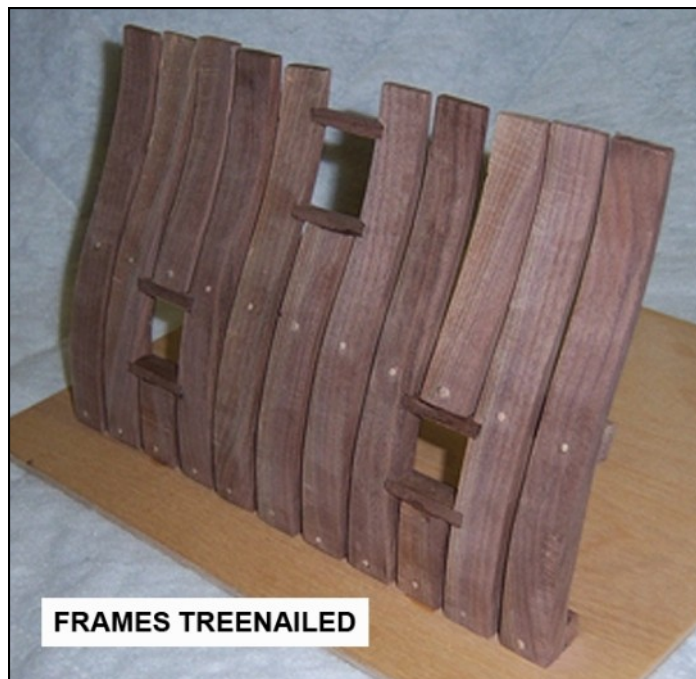
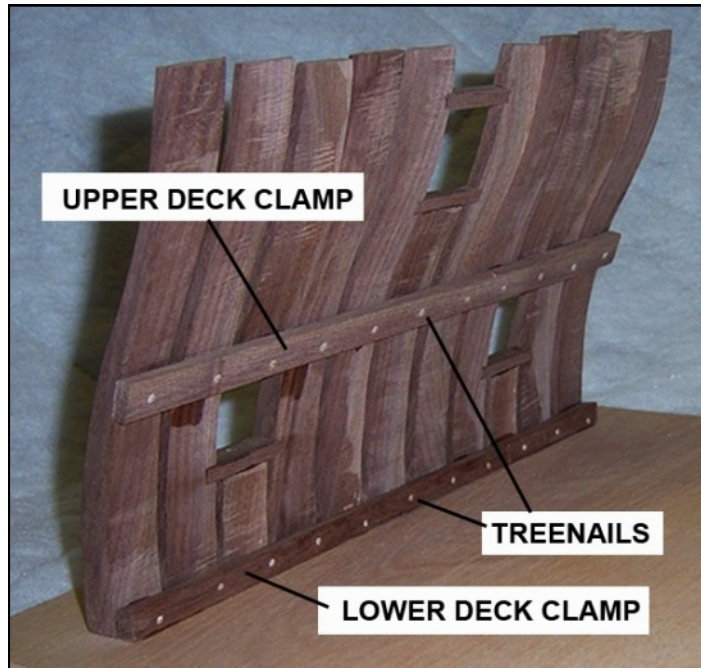

In our next step we'll build and plank the lower deck.



## Part 3 Lower Deck Framing and Deck Planking

For this step we'll be using sheets 9, 10, and 11.

Using the templates on page 10 cut out parts J to M then sand all parts to the finished sizes.

Cut notches in two of the parts J to hold the beam support M.

To assemble the beams follow the layout on sheet 9. Start by gluing the two outer parts J to the lower deck clamp and supports.

Next add the two notched parts J.

Measure the location and glue the remaining parts J in place.

Now attach part M spanning the two notches, then glue in the short beam L.

To finish this step glue the two hanging knees K on the inside of the outer deck beams. Drill and treenail as shown.

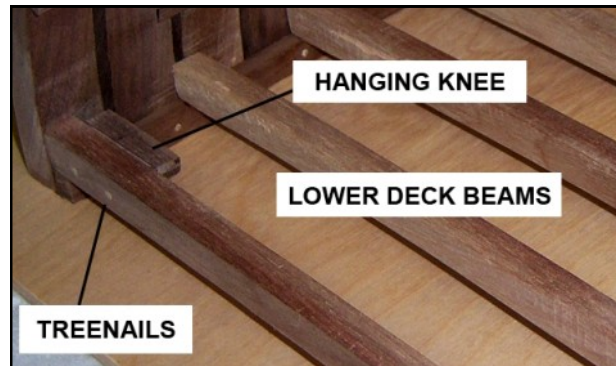

### Planking and Treenailing the Deck

Although this step is relatively easy, take your time with it. Personally, I think a good planked deck really adds to the look of the model. Take a little time to study sheet 11, especially the running joints in each row.

Cut the planking in strips of the correct length and width. Check for uniformity and the fit between rows. They should have a nice tight joint.



Now, before starting to glue the pieces in place slightly bevel the top edges, including the running joints.

Lay the planking starting from the edge closest to the frames, working towards the outside edge. When you get to the cut out for the hatchway, leave 1/2 of the deck beams exposed - see picture below. This is where the hatchway will be attached later.

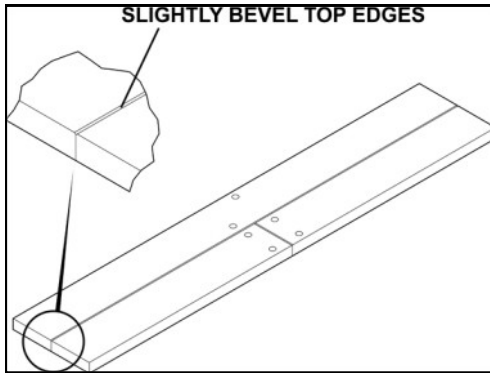

After the glue dries sand the planking lightly with a fine grit sandpaper.

Now we're ready to treenail the planking. Start by referring back to sheet 11 for the nailing pattern.

Take a pencil and lightly mark a point for each location. Keep the rows straight, a light pencil line can help. An awl works well to create a small starter hole prior to drilling. Now drill all of the holes. No need to drill real deep into the beams, just enough to secure the treenail in place. Yes, it's tedious! But the final results will be well worth it. Glue all treenails in place, then trim and sand flush.

Finally give the deck planking a good finish sanding using an extra fine sandpaper.

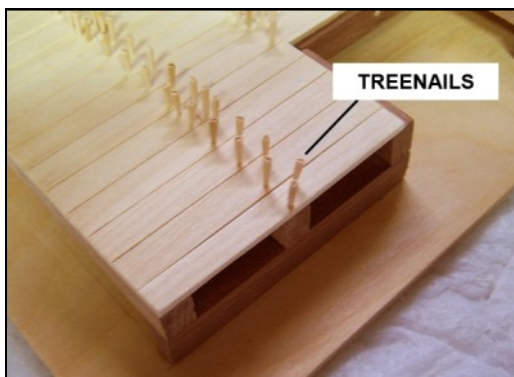



## Part 4 Lower Inside Spirketing, Waterway, and Gunport Ring Locations

Spirketing is a nautical term for the planks which will cover the inside edge of our battle station. The waterway is a plank at the outer edge of the deck which directs water overboard via the scuppers, a drain port in the side of the vessel.

This step in the build is relatively straight forward. Keep in mind that we'll be repeating this same process after we've built the upper deck.

Refer to sheet 2 of the plans for the thickness and width of the planks, as well as the profile of the waterway. With the exception of cutting short pieces to go around the gunports, all of the planking runs the entire length of the side. Start by gluing the bottom piece in first, working upward. Sand the waterway to the correct finished profile, and assemble it to the unit as shown. Finish up by treenailing along the outside edges, both sides of the gunports, and a row down the center.

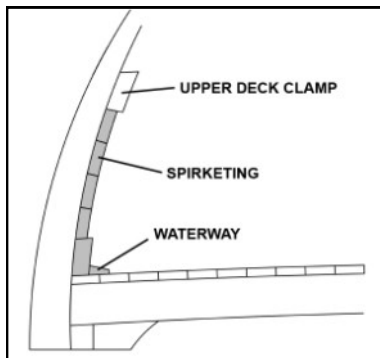

### Making and Locating the Gunport Rings

We will need to make twelve gunport rings for the battle station; eight for the lower deck, four for the upper. At 1:32nd scale a small paperclip works well for these. The following pictures show the process used to create the rings.

There are several ways that the rings can be finished to achieve an aged iron look. Painting them flat black is one. For mine I used a process which works pretty well. First heat the ring over an open flame. A candle works best for this. Remember to hold it with a pair of pliers, as they get very hot. As soon as it begins to turn red take it away from the heat and quench it in water. This is like a heat treat process, and it will give the metal a nice dark tarnished look. Now trim the end back, keeping it long enough to attach to the sides.



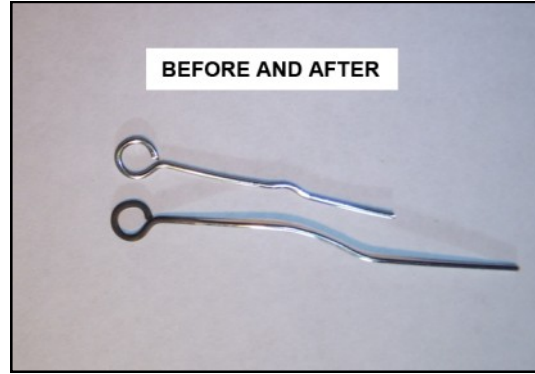

The final step is to locate and drill the holes for the gunport rings. DO NOT glue the rings in place at this time. We'll attach them when rigging the gun and carriage later.

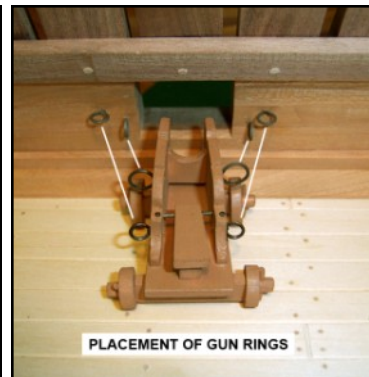
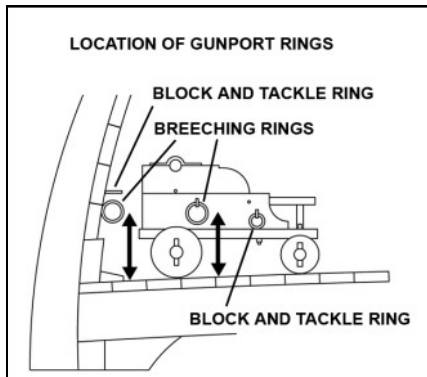

In the next part we'll build and plank the upper deck, as well as repeat the process of adding the spirketing, waterway and gunport rings to the upper inside.



## Part 5 Top Deck Framing

Begin by cutting all of the parts out on template page 13.

Next glue carlines S, to deck beams N and O, keeping everything nice and square.

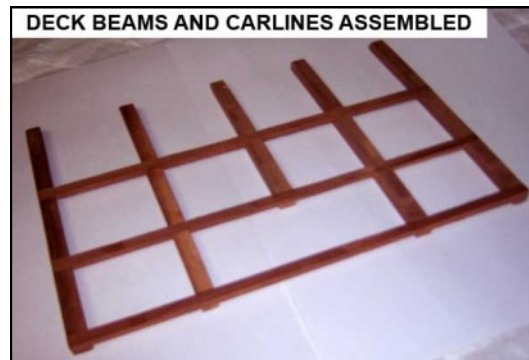
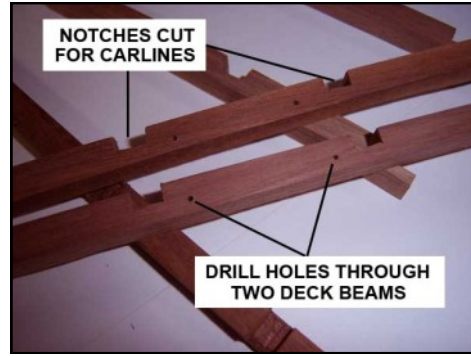

Check the deck framing for good alignment with the upper deck clamp. Sand as needed.

Study the layout on page 12 for the ledge locations. Measure and cut notches in the carlines for the ledges.

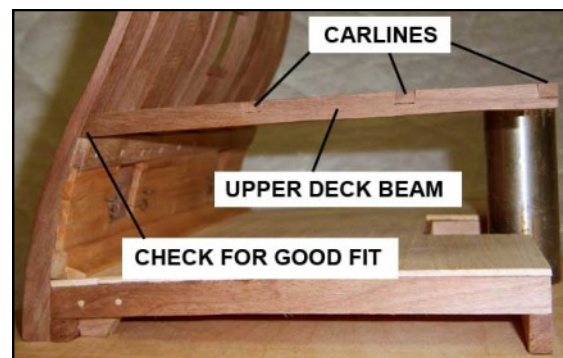
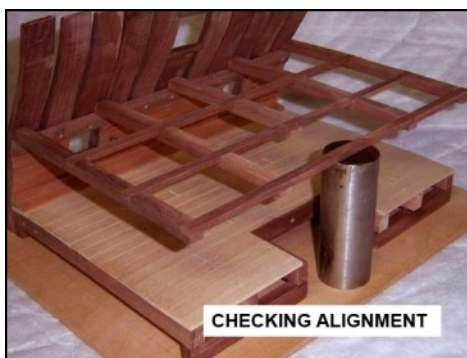

For mine I notched only the areas that I plan to leave open after the deck planking is in place. Glue all in place except the rows between to the deck clamp and carline, which will be added after the lodging knees are in place.

Treenail the deck beams and carlines. Extend the row of treenails where the columns attach below the deck as shown. This will be used for an alignment point. Drill a hole in the top of the columns S, then glue the col-



umns to the lower side of the deck beams. After it dries flip the deck over and glue it in place on the unit. Clamp as needed till dry.

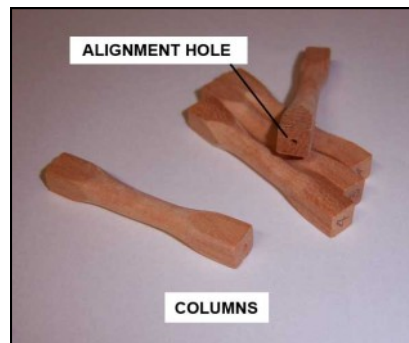
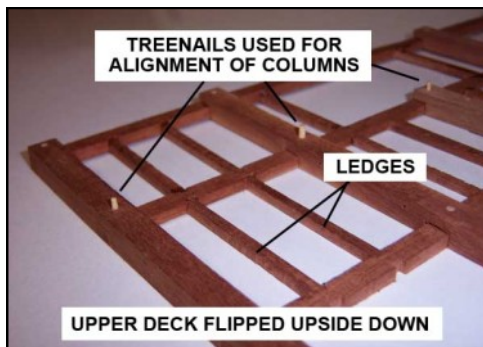
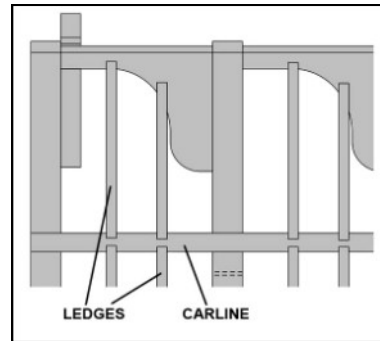
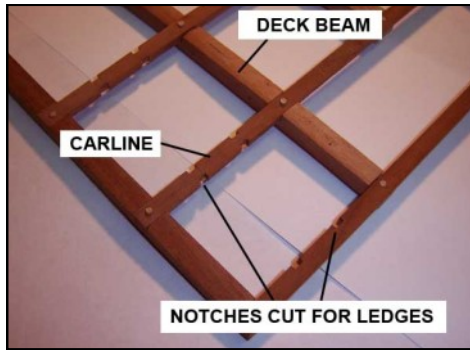

Now attach the three hanging knees P, to the deck beams, followed by the lodging knees Q. See the pictures

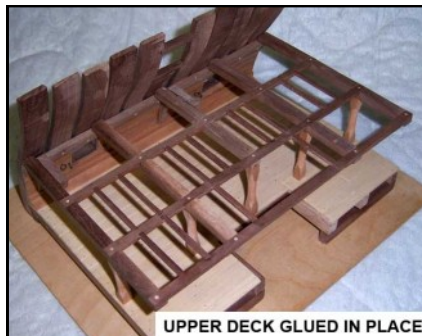

below. Finally glue the remainder of the ledges in place, spanning the distance between the carline and lodging knee. Treenail the two outer deck beams and hanging knees together.

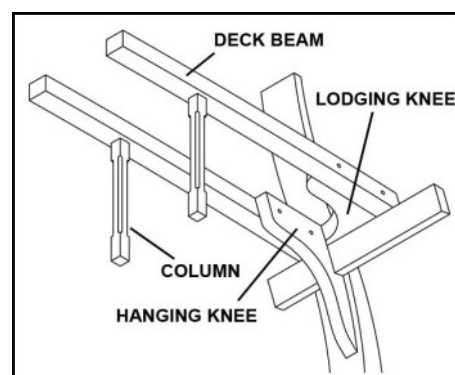
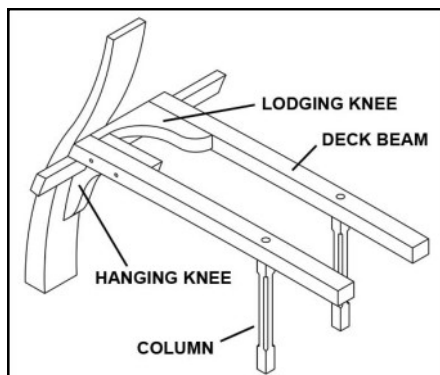

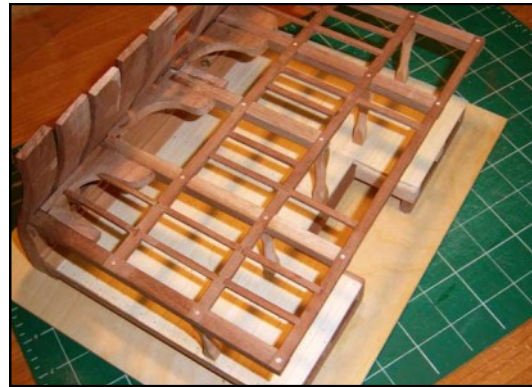

### Deck Planking, Spirketing, Waterway and Gun Rings

The plans show one way to plank the upper deck, leaving the ends exposed to see the lower deck area below. This also allows easy access to the drilled holes in the two deck beams where we will be installing the gun-port lid block and tackle later. Its entirely up to you as to how much of the deck you want to plank. Finally treenail the deck and sand smooth.

The process of installing the spirketing, waterway and gun rings is the same as what was done for the lower deck.

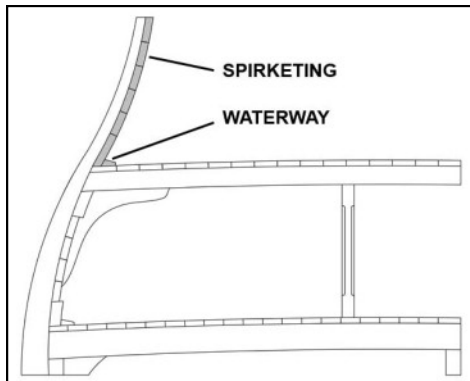

In the next part we'll plank the outside of the frames.



## Part 6 Outside Wales, Strakes and Gunwale

For this step refer to sheets 1 and 2 of the plans for the planking arrangement. For my battle station I've painted the lower wale and two upper strakes flat black, copying a circa 1675 model of a 44-gun ship at the National Maritime Museum in England.

Start by installing the lower wale first. Then work your way up the side alternating between the strakes, channel wales, strakes, etc. till you get to the top.

Before installing the gunwale cleanup the top surface of the frames and planking, making sure you have a good flush fit. Now install the gunwale.

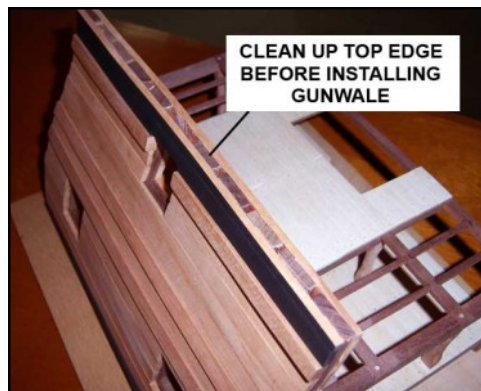
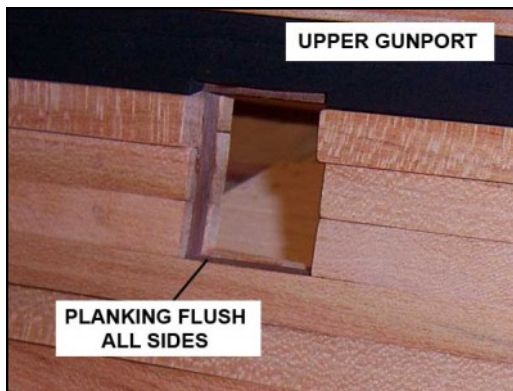
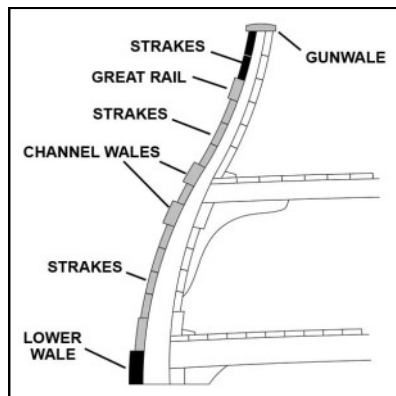



## Hole for Gunport Lid Rigging

Now drill the two holes necessary to allow the lower gunport lids to be rigged. First, determine the location from sheet 1. Mark the location on the planking with an awl. Using a drill bit that is large enough to allow the rope to pass through freely, drill from the outside through the inside planking, keeping the hole just below the lodging knees.

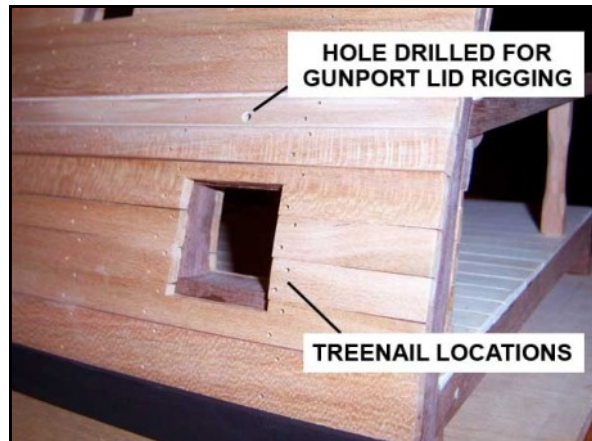
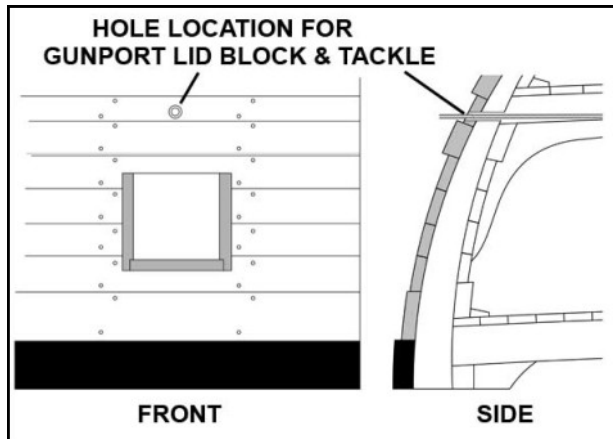

## Treenailing

Using the locations shown on sheet 1 drill and install all of the treenails. Finish sand all of the planking and treenailed surfaces.



In the next part we'll install all of the deck details.



## Part 7 Deck Details

### Hatch Coaming and Grating

Hatch coamings are the raised frame around a hatch; it forms a support and strengthens the edges of the opening. For our battle station we will have three, two with grating and one for the opening for the ladder that goes between the decks. Cut out and glue the coamings together keeping edges squared up. Do not glue them in place at this time.

For the grating start by making a series of kerf cuts in a wide piece of material. Now cut it into strips, along with cutting out the notches as shown. Glue strips into the notches keeping everything square. Repeat the process until you have a grid that is slightly larger than the coaming opening. Trim down to the final opening size and glue into place. Finish sand all of the surfaces.

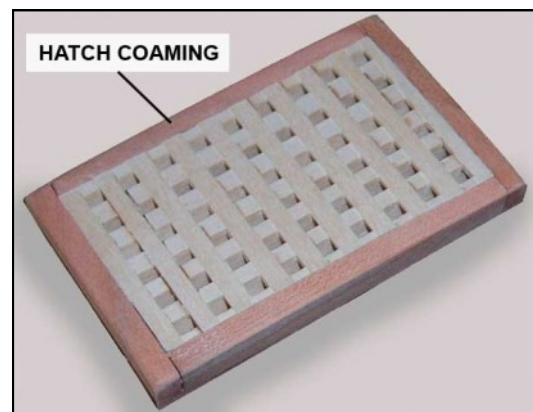
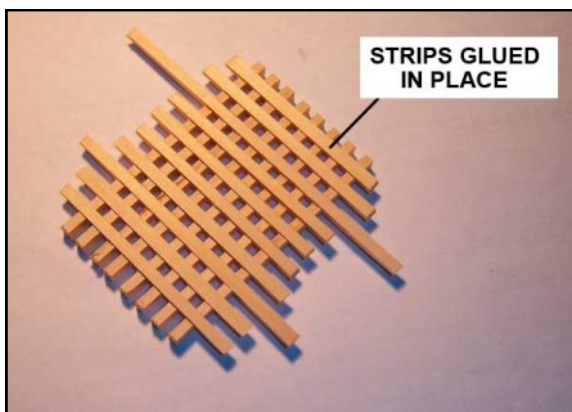
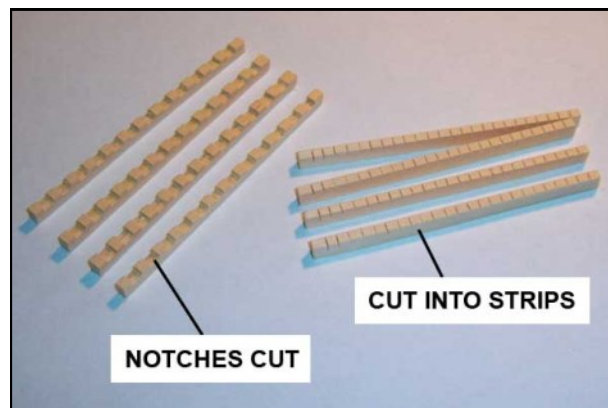
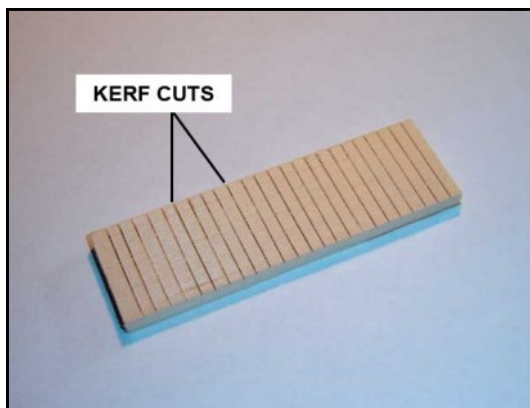

### Shot Racks

Cut the shot racks to size. Mark and drill a series of holes just deep enough to cradle the round shot. For the 1:32nd scale version I used a 5/32" drill bit. 5mm metal beads found at my local craft store worked well for the solid shot, which I painted flat black. If you are planning on applying some type of finish on your



model don't glue the solid shot in the rack until afterward.

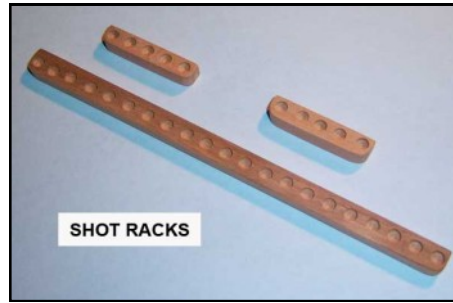

## Ladder

Cut the sides for the ladder, and notch for the steps as shown.

Start the assembly by gluing the top and bottom steps in first. Make sure everything is good and square, clamp and let dry. Finish by gluing the remaining steps in place.

Glue the details in place on the battle station now.

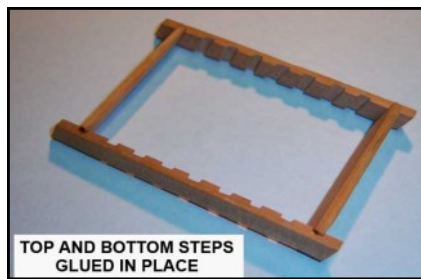
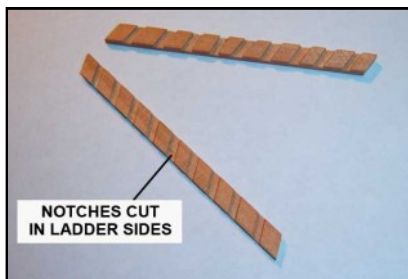

At this stage of the build clean up and finish sand the entire unit as well as applying the type of finish you like. This should be done before the guns are put in place and rigged, which is the next part.





## Part 8 Gunport Lids & Rigging

For the gunport lids and rigging refer to sheet 16.

Start by cutting out and assembling the lids. Make sure that they are slightly smaller than the openings for the gunports.

To make the hinges I used .010" brass pieces that I cut to size then formed a loop on the end for the pin, which is a small brass nail trimmed to size. Now drill holes for attachment to the lid, and paint everything flat black.

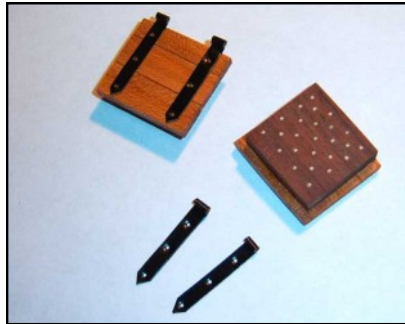

Make 2 sets of rings, one for each lid.

Attach the hinges to the lids using straight pins and CA glue. Locate, drill and install the rings.

Attach the lid assembly to the battle station. For mine I used 5 minute epoxy to glue them in place. Brace them in the open position until they are good and dry.

### Making Blocks

The blocks are relatively easy to make by following the sequence as shown below.

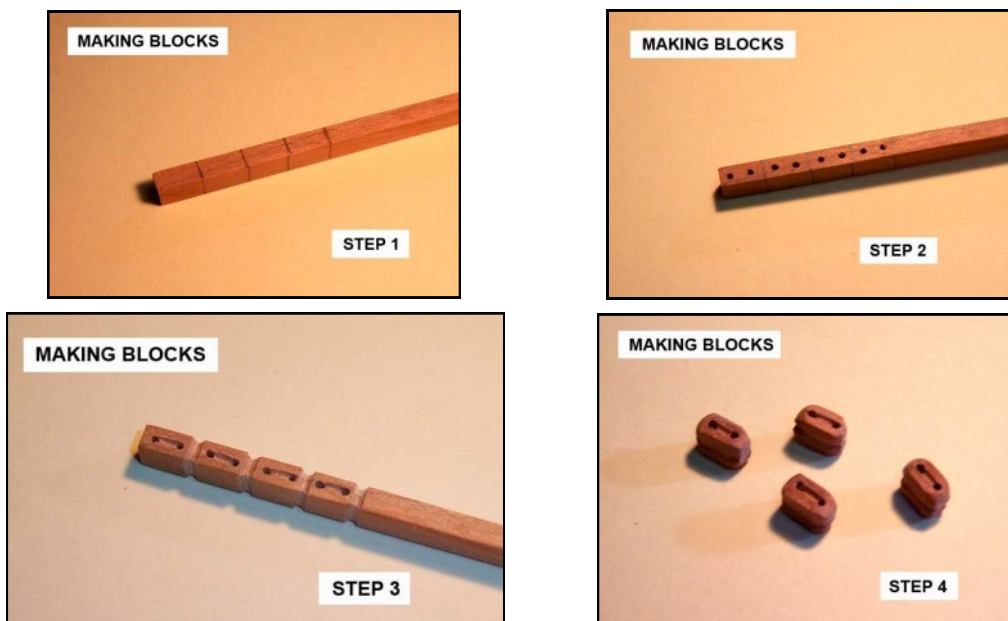



## Cleats

Make two cleats to attach the rigging to under the deck. Attach to the upper deck beam.



## Stropping the Blocks

A strop is a spliced loop of rope around a block which formed a ring for attaching it. Make a ring of rope large enough to wrap around the block and be able to wrap a splice around the end to form a loop as shown.

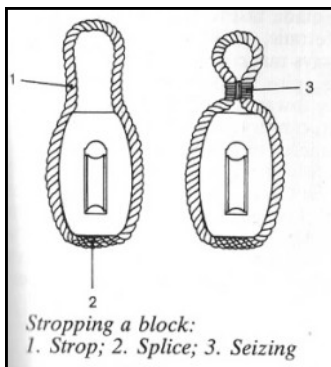

## Rigging the Blocks

Rig the block together as shown. Don't glue any of this together yet.

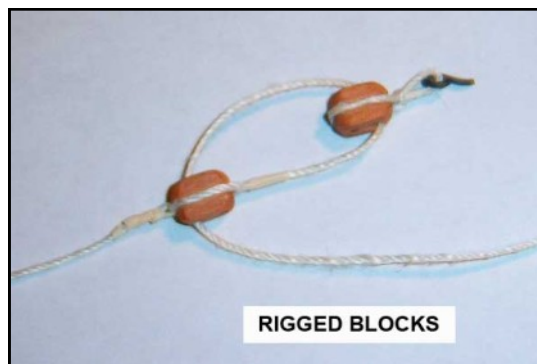



## Attaching the Rigging to the Battle Station

Start by gluing the block with the ring to the hole in the deck beam. One of the loose ropes goes to the gunport lid rings, the other wraps around the cleat. Pull them until they are taunt, and secure them in place with a drop of glue. After it dries wrap splicing around the end of the lid rope. Repeat this process for the second set.

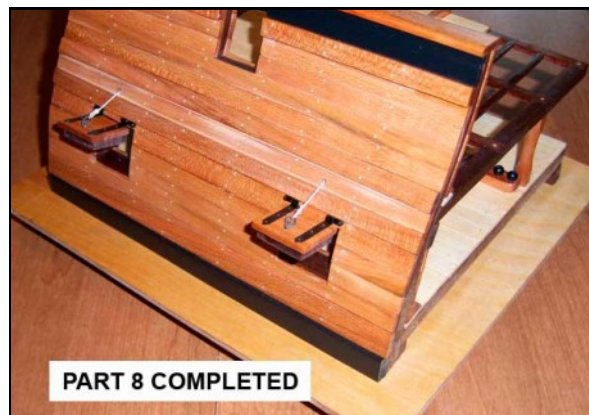
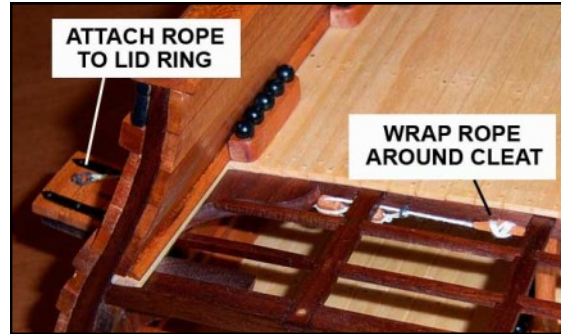

Our the last section we will be making and rigging the guns, then finalizing the build.



## Part 9 The Final Stages

### Guns and Rigging

To make the gun carriages cut out and assemble them using the templates and drawings in the plans.

There are several ways to create the guns. The most obvious way would be to turn them on a wood or metal lathe. If you don't have access to one, here's an alternative method that works well.

Start by measuring the basic gun barrel length between both ends. Select a dowel that's the same diameter as the rear, or largest end. At 1:32nd scale 1/2" works well. Now measure the location of the trunnion. Mark and drill through the dowel at this location. Measure the diameter of the smallest end of the barrel and transfer this to the end of the dowel. Sand the dowel until its tapered from the largest to smallest diameter.

Create and glue the end discs on the barrel CA glue or 5-minute epoxy works best for this step. I then used two small washers to give the rings a stepped down look, and finally added a metal bead for the cascabel. Cut a dowel for the trunnion, and glue it in place.

For the banding use strips of tape at the correct locations. You will need to wrap it several times until its raised up enough. Now carefully drill the hole into the barrel. It doesn't have to be real deep, just enough to give the appearance of being that way. Finally paint them flat black and your done.

Attach the barrels to the carriage with the straps that you have made.





Now make all of the rings and blocks using the method shown in the earlier part of the build. For the guns we'll need six single, and six double blocks. Strop and rig the blocks as shown.

Make the large breeching rope and attach it to the gun assembly as shown.

To rig the guns to the deck start by gluing the top rings for the block and tackle in place on the sides. Place the gun and breeching rope assembly in place, and glue the lower ring into the side. Carefully place a small drop of glue under the rear wheels and attach the unit to the deck. Pull the breeching rope back, creating slack towards the rear and attach to the deck with a small drop of glue.

Now were ready for the block and tackle rigging. This step will require some patience on your part! Attach the hook on the double block to the ring in the side of the unit, followed by hooking the rear ring on the carriage with the single block hook. Using the loose end of the roping carefully take the slack out of the rigging by pulling towards the rear until its snugged up some. Don't pull it too tight or you may be doing the process over again when it lets go.

Finally loop the loose ends of the rope and attach them to the deck.

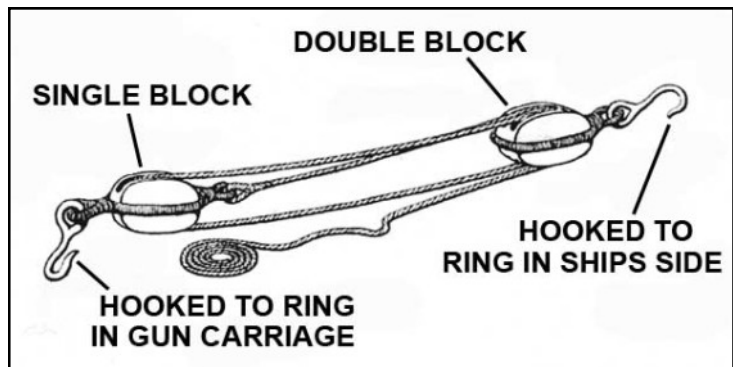
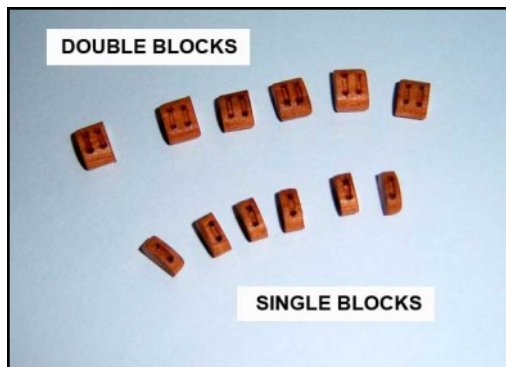



## Gunport Wreath (optional)

I need to give a big thank you to Gene Bodnar for this method. Here's how it's created.

Start by cutting a ring out of basswood. At 1:32nd scale use wood 1/8" thick. Sand the edges round.

Using cardstock cut out each of the leaves, attach them one at a time to the ring using CA glue.

Cut a strip of masking tape for the 4 ribbons, and wrap the wreath back and forth several times.

To finish up spray paint it gold. For mine to create an antique look I did the following: Start by spray painting the wreath flat black. Then dry brush it with an antique gold paint.

Glue the wreath to the upper gunport centering it around the opening.



## Additional Deck Accessories

For the purpose of our build we won't be incorporating any additional accessories to the model. For those who might wish to here's some ideas of things that could be considered:

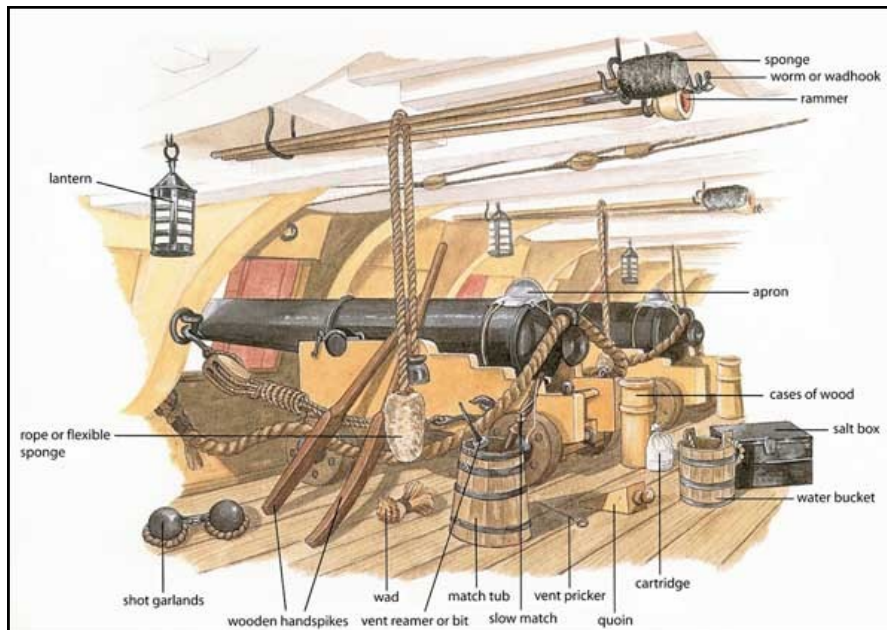



## Base

Adding a base to the model gives it a nice finished look. Be careful not to get too elaborate with it...after all the focus should be on the actual battle station, not the base. For mine I made a simple frame of basswood, and added a trim piece on top of it to create a shadow edge. I chose painting it flat black to repeat the black pattern of the strakes. Here she is completed:





The Battle Station





I hope that you have found this build interesting and informative, and that perhaps you've learned a few thing along the way. If you have any questions or comments don't hesitate to post them in the Navy Board Models website Forum . We'll do our best to answer them. Also, I'd again encourage you to create an online build log of your progress. There's nothing more interesting than seeing how different builders create their own versions of the model.

Happy Building!

Jeff



## Appendix A

### Battle Station Material List - 1:32 Scale

Drawing Part	Part Name	Quantity	Material	Dimensions	On Sheet
A	Frame	2	3/4"	1" x 6-1/2"	7 of 16
B	Frame	4	3/4"	1" x 6-1/2"	7 of 16
C	Frame	2	3/4"	3/4" x 3-3/4"	7 of 16
D	Frame	2	3/4"	5/8" x 1-1/2"	7 of 16
E	Frame	2	3/4"	1" x 6-1/2"	7 of 16
F	Frame	1	3/4"	1" x 4-1/2"	7 of 16
G	Frame	1	3/4"	1/4" x 1/2"	7 of 16
H	Gunport Sill	6	3/16"	1/2" x 1-3/16"	7 of 16
J	Lower Deck Beam	6	3/8"	5/8" x 7"	10 of 16
K	Hanging Knee	2	1/4"	7/8" x 1-1/4"	10 of 16
L	Lower Deck Beam	1	3/8"	5/8" x 5-1/4"	10 of 16
M	Deck Beam Support	1	3/16"	7/16" x 2-7/8"	10 of 16
N	Upper Deck Beam	4	3/8"	1/2" x 6-3/8"	13 of 16
O	Upper Deck Beam	1	3/8"	1/2" x 4-5/8"	13 of 16
P	Hanging Knee	3	1/4"	2" x 2"	13 of 16
Q	Lodging Knee	4	1/4"	1-5/8" x 2"	13 of 16
R	Column	5	1/4"	1/4" x 2-3/8"	13 of 16
S	Carling	3	1/4"	1/4" x 9-1/2"	13 of 16

Misc. Parts	Part Name	Quantity	Material	Dimensions	On Sheet
	Mounting Base	1		9-5/8" x 11-9/16"	5 of 16
	Lower Deck Clamp	1	1/4"	5/16" x 9-1/2"	2 of 16
	Upper Deck Clamp	1	1/4"	1/2" x 9-1/2"	2 of 16
	Support	2	1/4"	7/16" x 9-1/2"	2 of 16
	Deck Planking	30	3/32"	3/8" x 9-1/2"	2 of 16
	Spirketing	11	1/8"	7/16" x 9-1/2"	2 of 16
	Waterway	2	1/8"	1/4" x 9-1/2"	2 of 16
	Lower Wale	1	1/4"	9/16" x 9-1/2"	2 of 16
	Strakes	11	1/8"	7/16" x 9-1/2"	2 of 16
	Channel Wales	2	3/16"	7/16" x 9-1/2"	2 of 16
	Great Rail	1	3/16"	3/8" x 9-1/2"	2 of 16
	Gunwale	1	1/8"	1/2" x 9-1/2"	2 of 16



Battle Station Material List - 1:32 Scale

Misc. Parts	Part Name	Quantity	Material	Dimensions	On Sheet
	Rails	20	1/8"	1/8" x 2-1/4"	12 of 16
	Lower Shot Rack	1	3/16"	1/4" x 5-1/2"	15 of 16
	Upper Shot Rack	2	3/16"	1/4" x 1-1/2"	15 of 16
	Lower Hatchway	1	1/4"	1-3/4" x 3"	15 of 16
	Upper Hatchway	1	1/4"	1-7/8" x 3"	15 of 16
	Stairs	12	3/32"	1/4" x 3-1/4"	15 of 16
	Gunport Wreath	1	5/16"	2-1/4" x 2-1/4"	15 of 16
	Gunport Lid	4	1/8"	1-1/4" x 1-3/8"	16 of 16



## Appendix B

**Note:** The plans should be printed on 8.5 x 11" stock. Set scaling to NONE. Print one page first and confirm scale before printing all.

**Note To Copiers:** Copies of the attached drawings may be printed for individual use.

For further information please contact:

[winston@modelshipbuilder.com](mailto:winston@modelshipbuilder.com)

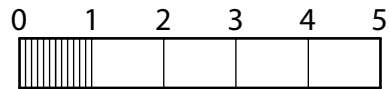
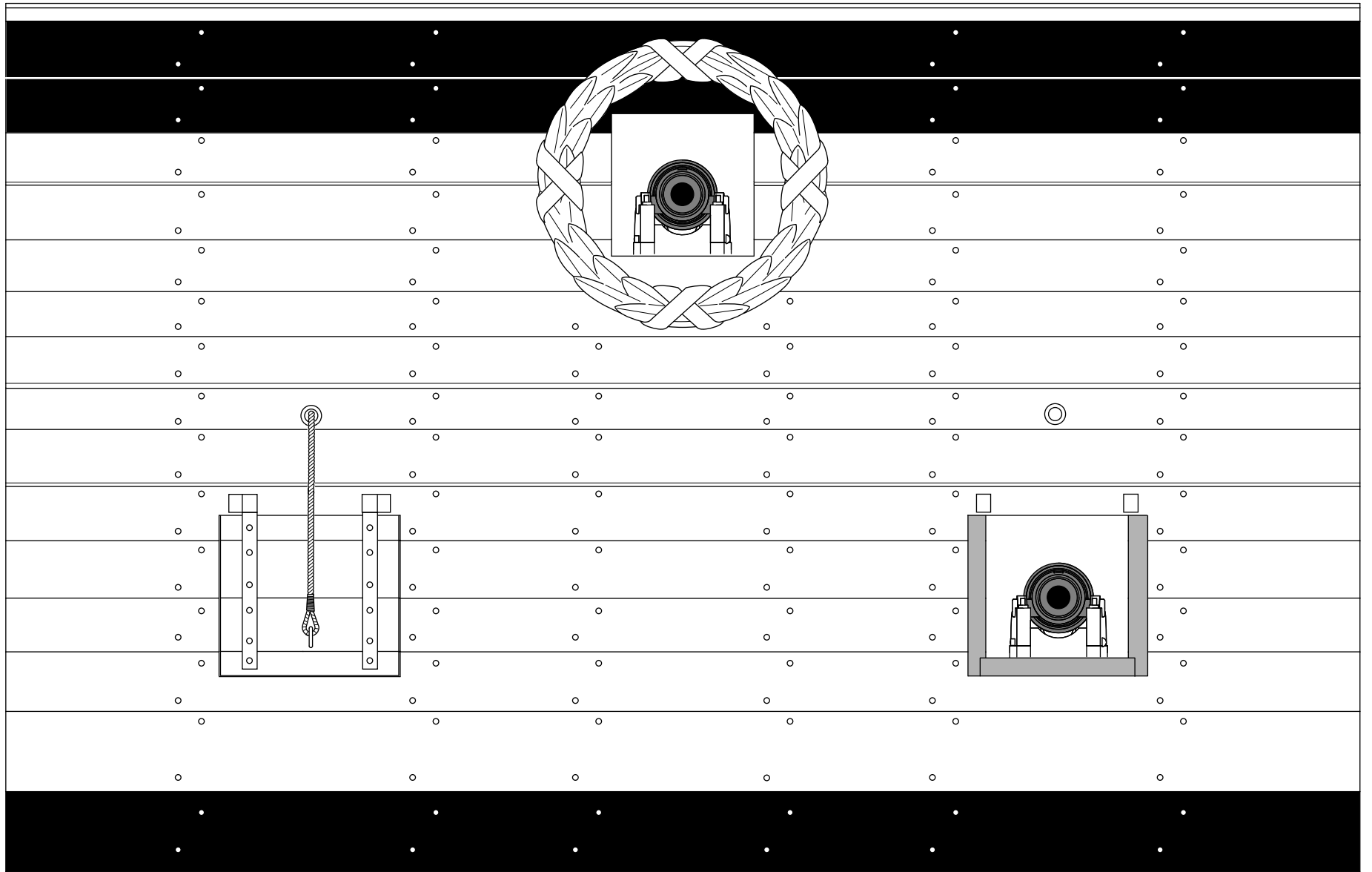

© 2009 Navy Board Models.com

<b>17th Century Battle Station</b>		
TITLE	BATTLE STATION - FRONT VIEW	
DRAWN BY	JEFF STAUDT	DATE
		MAY 2009
SCALE	1:32	SHEET
		<b>1 OF 16</b>

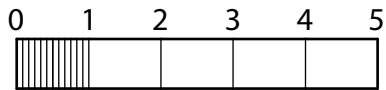
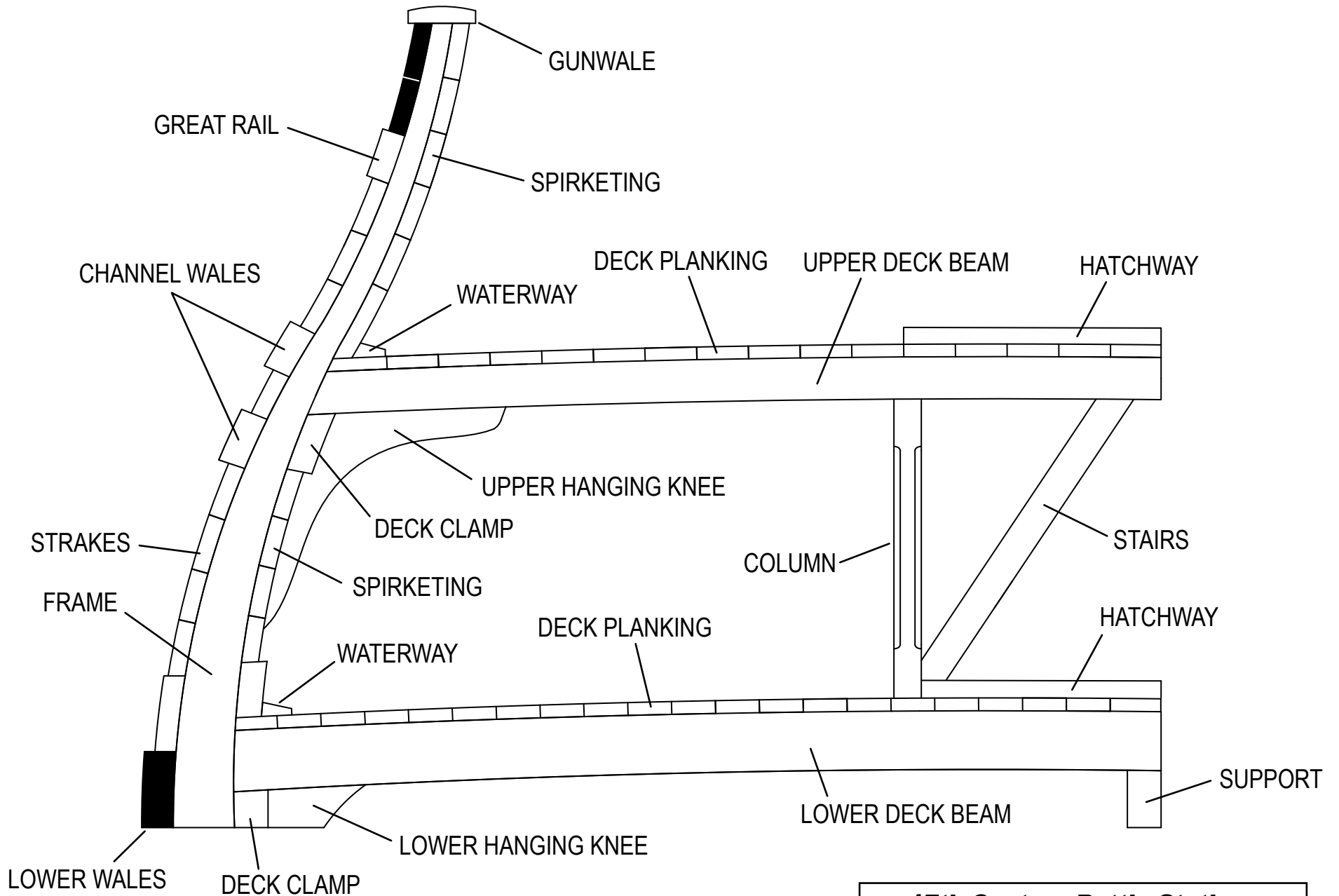

<b>17th Century Battle Station</b>		
TITLE	BATTLE STATION - SIDE VIEW	SHEET
DRAWN BY	JEFF STAUDT	DATE MAY 2009
SCALE	1:32	<b>2 OF 16</b>

© 2009 Navy Board Models.com

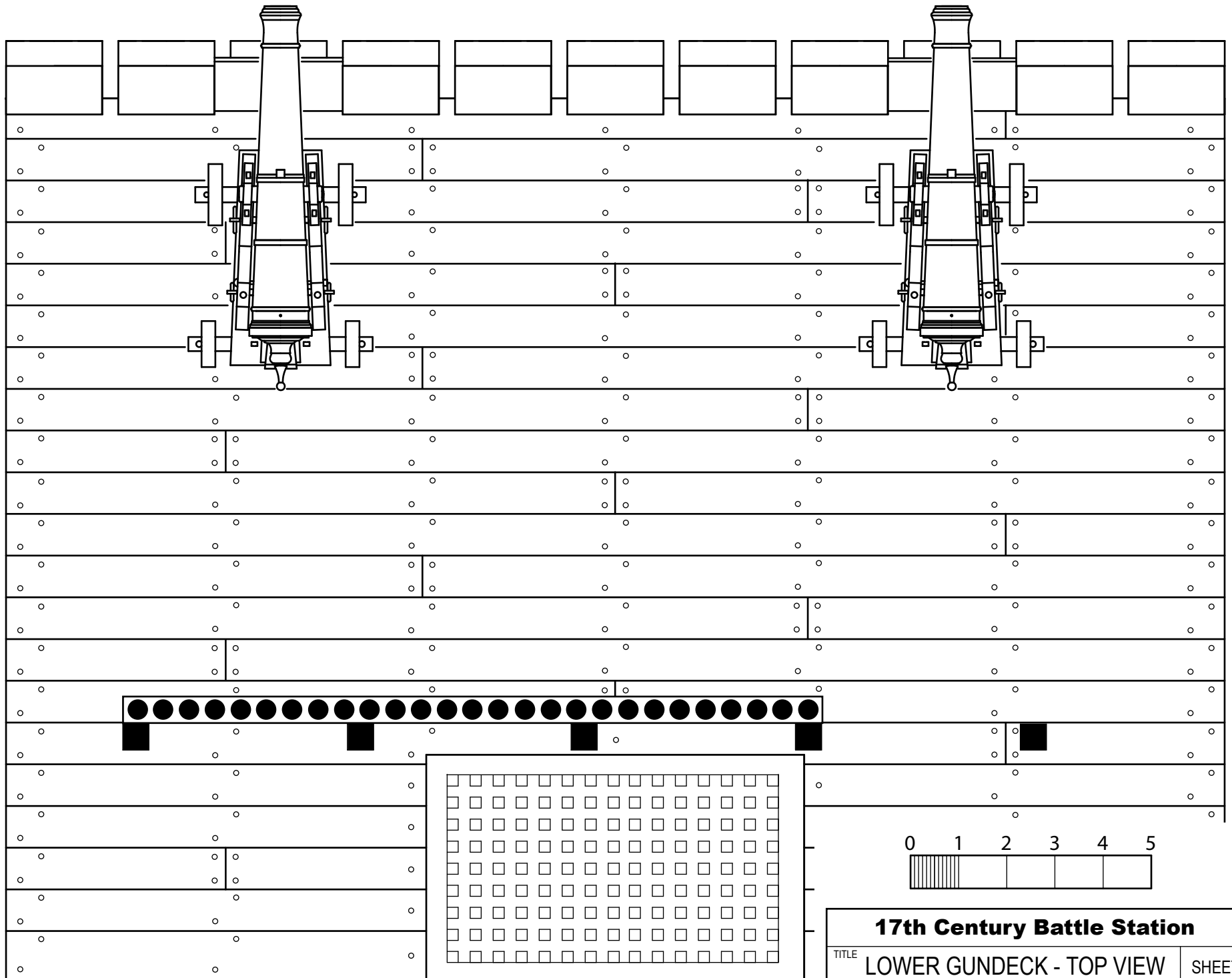

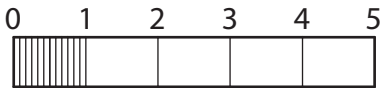
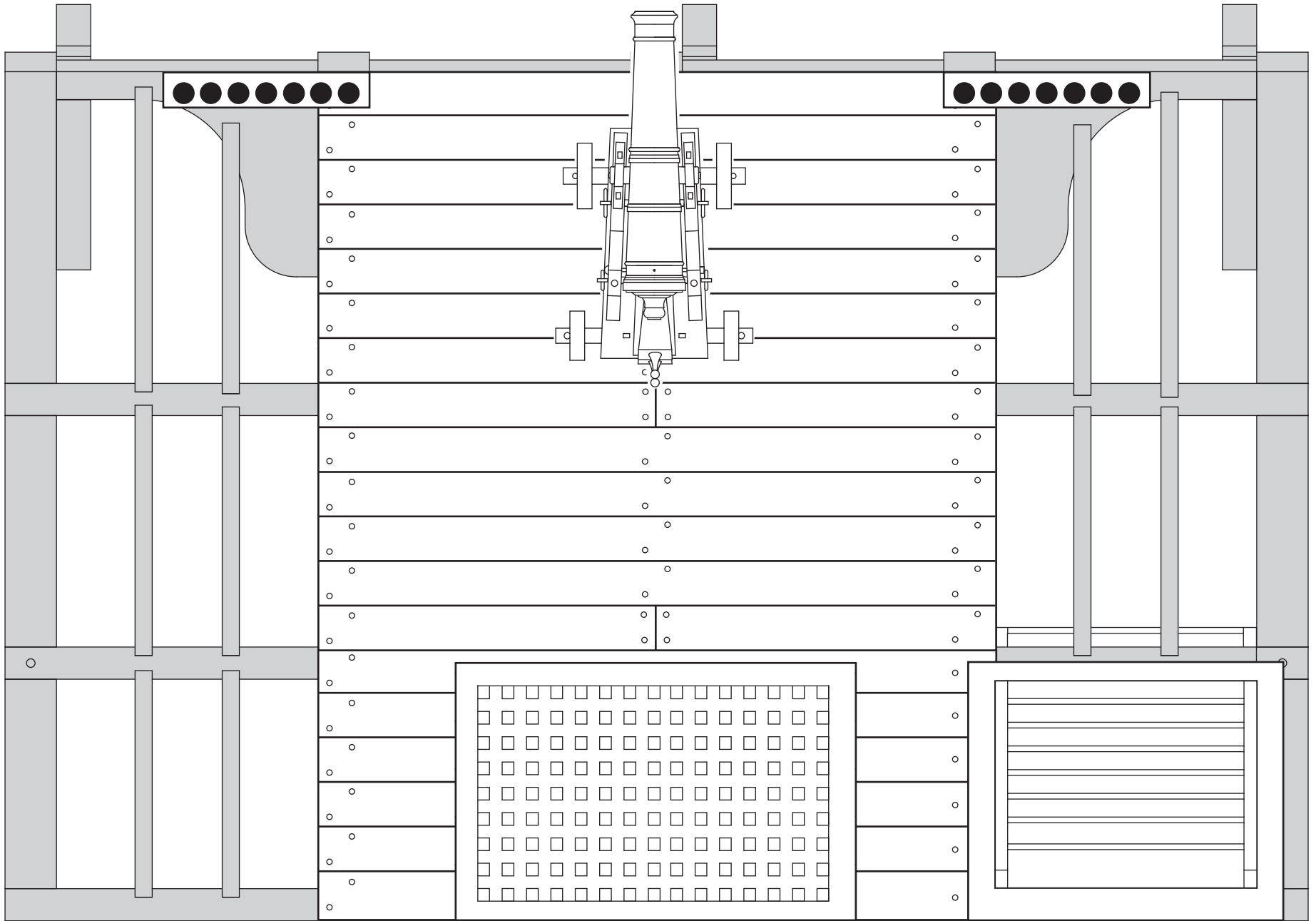

## 17th Century Battle Station

TITLE  
UPPER GUNDECK - TOP VIEW

SHEET  
4 OF 16

DRAWN BY JEFF STAUDT DATE MAY 2009 SCALE 1:32

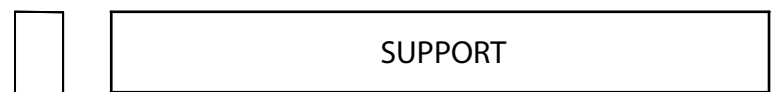
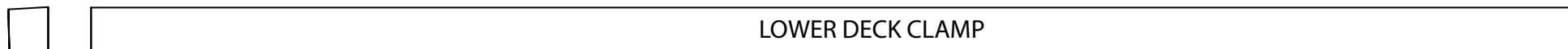
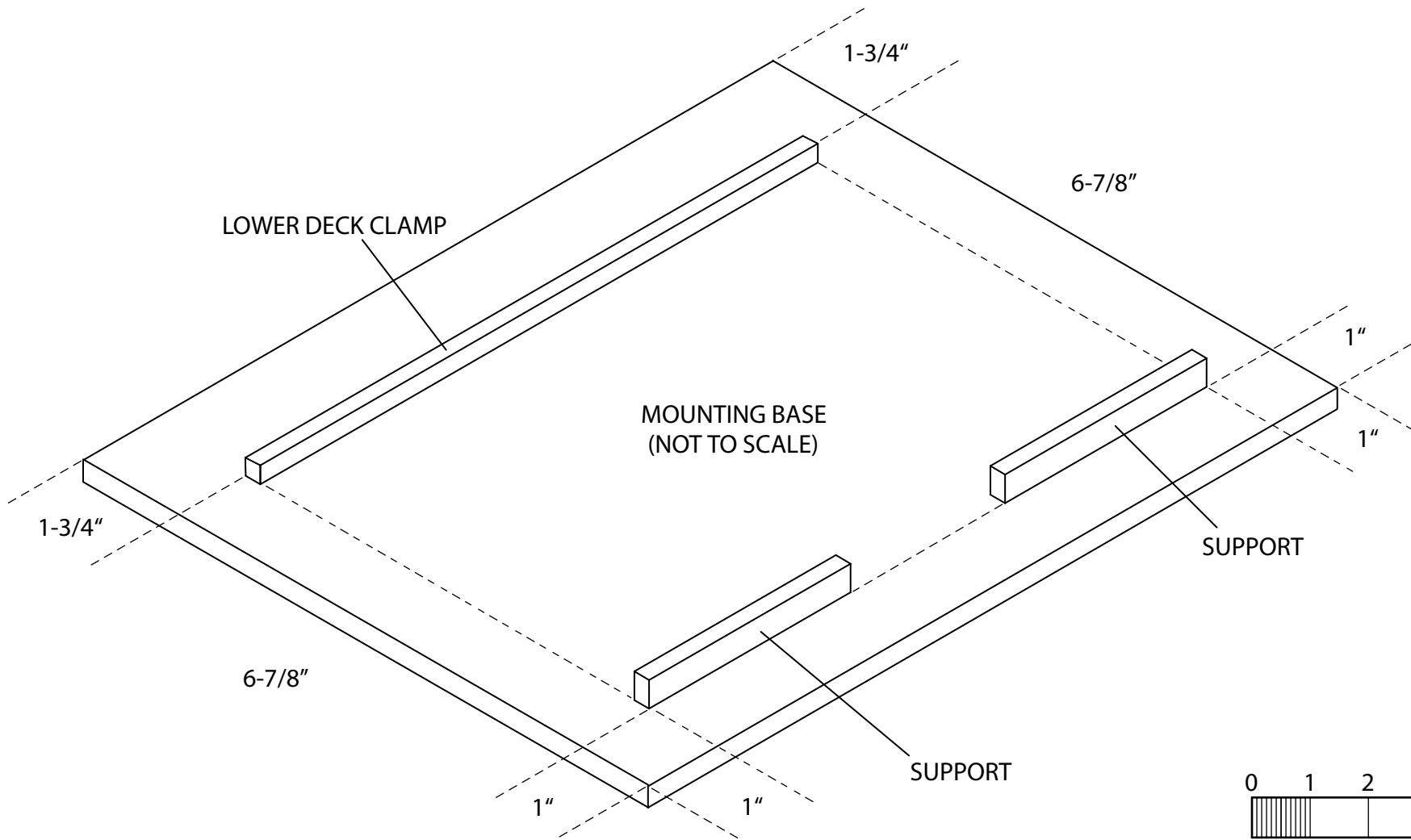

<b>17th Century Battle Station</b>		
TITLE	<b>BASE - DECK CLAMPS &amp; SUPPORT</b>	SHEET
DRAWN BY	JEFF STAUDT	5 OF 16
DATE	MAY 2009	SCALE 1:32

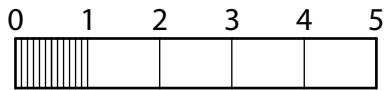
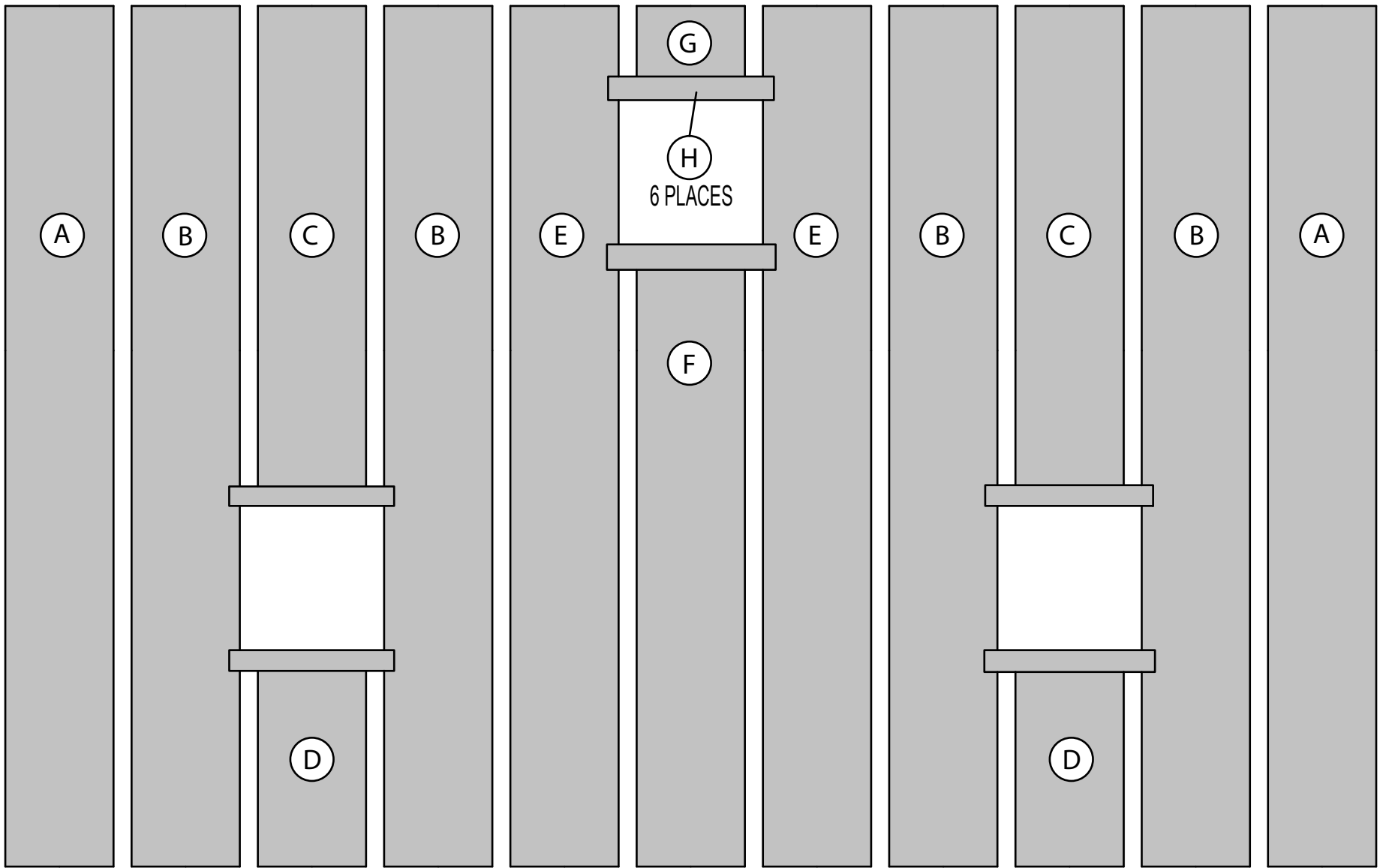

<b>17th Century Battle Station</b>			
TITLE SIDE FRAMING ASSEMBLY			SHEET
DRAWN BY JEFF STAUDT			6 OF 16
DATE MAY 2009		SCALE 1:32	

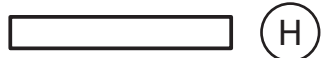
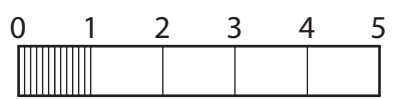
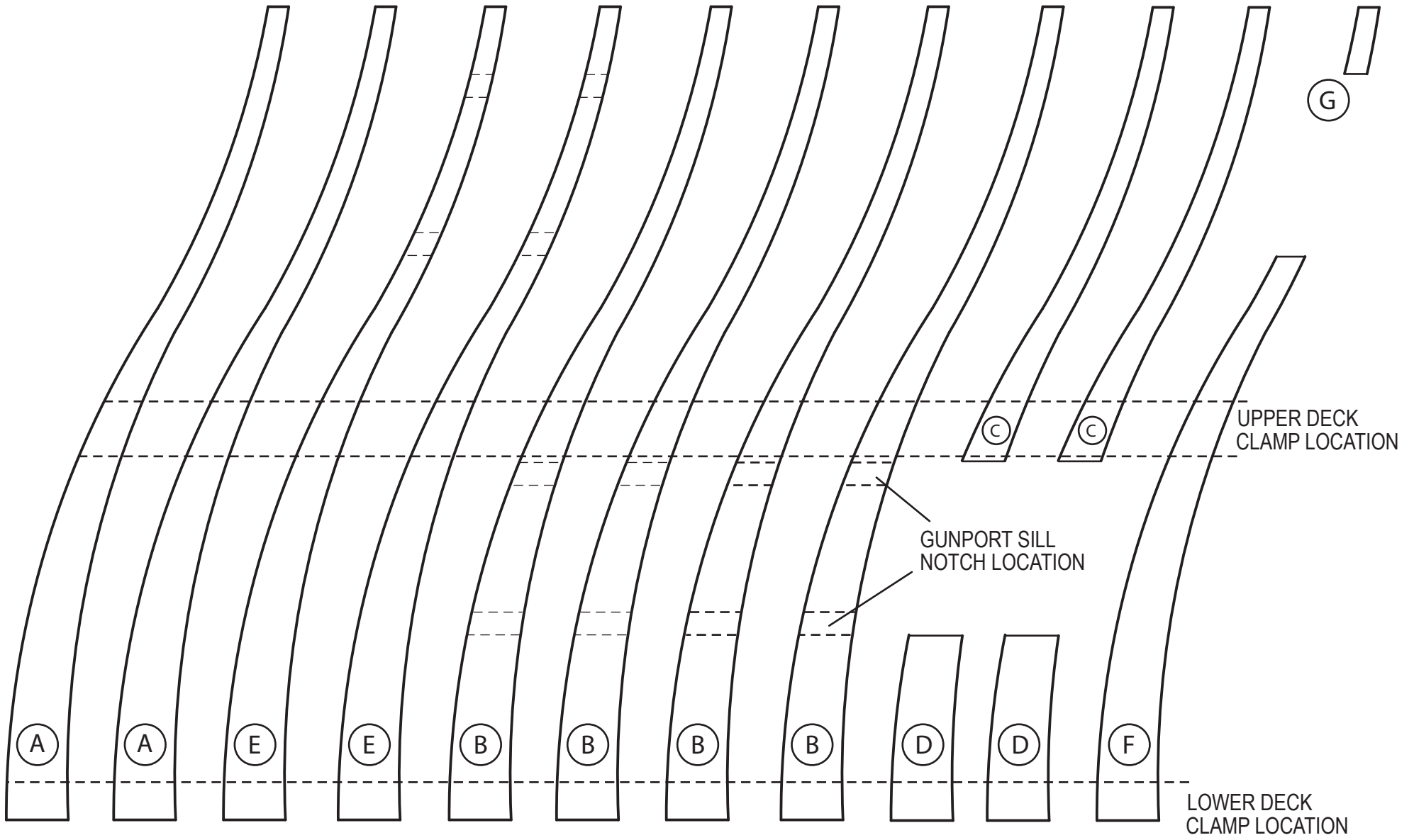

© 2009 Navy Board Models.com

<b>17th Century Battle Station</b>		
TITLE	SIDE PARTS TEMPLATE	
DRAWN BY	JEFF STAUDT	DATE MAY 2009
SCALE	1:32	SHEET 7 OF 16

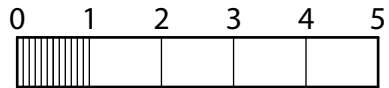
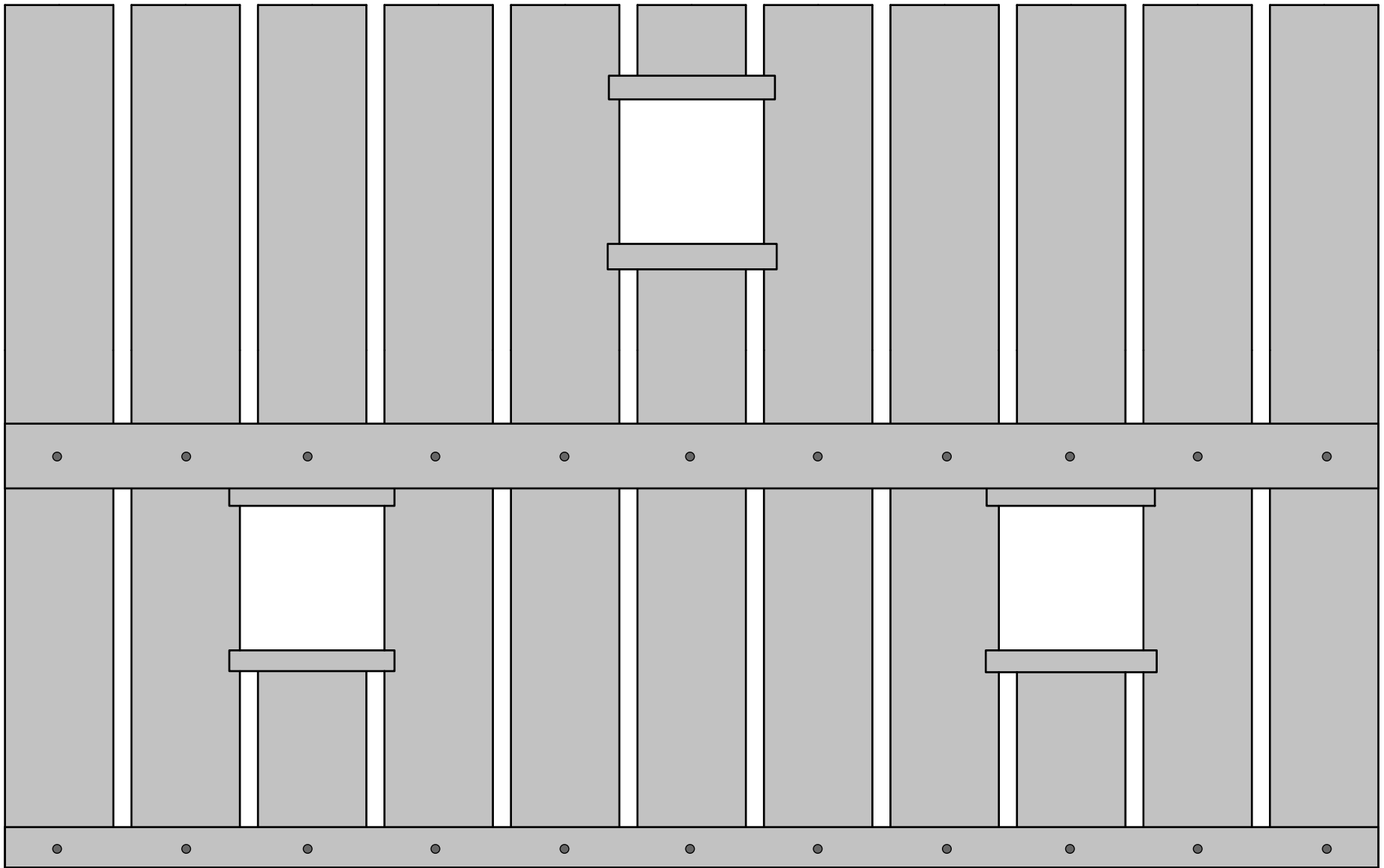

**17th Century Battle Station**

TITLE <b>SIDE FRAMING WITH DECK CLAMPS</b>			SHEET <b>8 OF 16</b>
DRAWN BY JEFF STAUDT	DATE MAY 2009	SCALE 1:32	

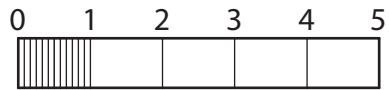
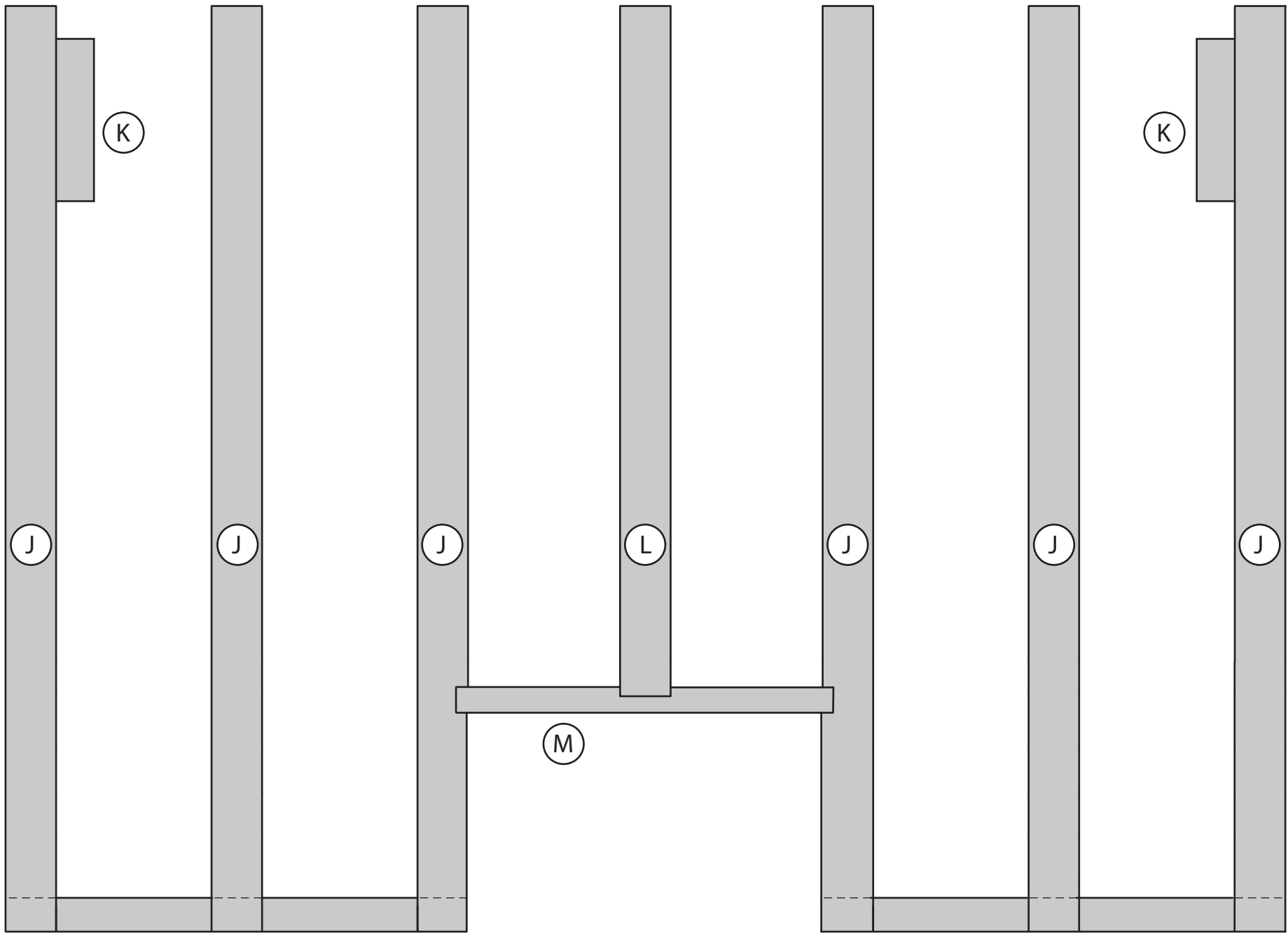

<b>17th Century Battle Station</b>		
TITLE <b>LOWER DECK FRAMING -TOP VIEW</b>		SHEET <b>9 OF 16</b>
DRAWN BY JEFF STAUDT	DATE MAY 2009	SCALE 1:32

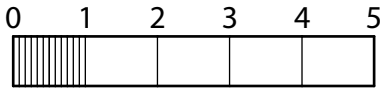
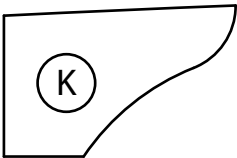
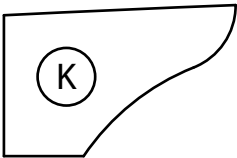
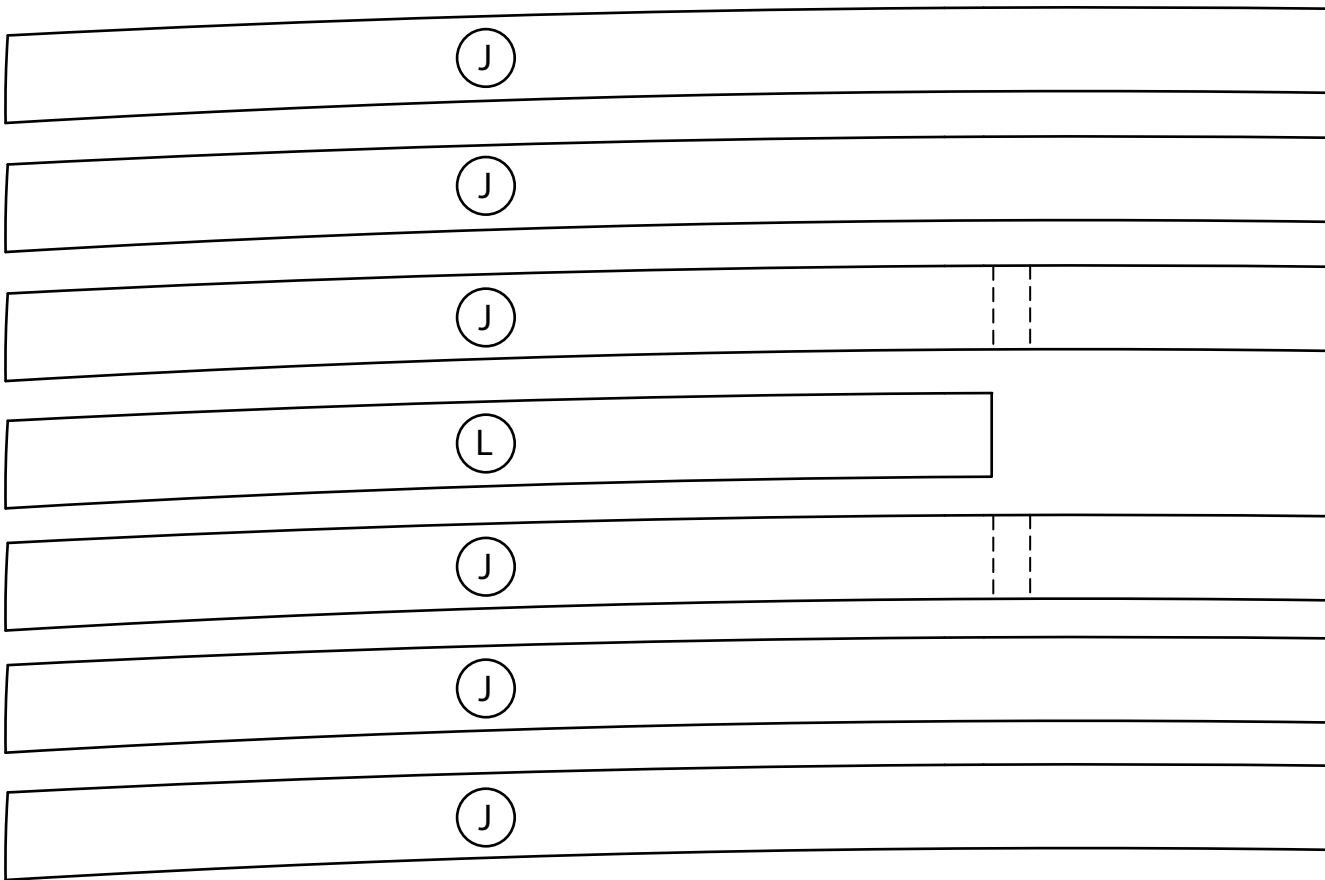

<b>17th Century Battle Station</b>			
TITLE		LOWER DECK PARTS TEMPLATE	
DRAWN BY	JEFF STAUDT	DATE	MAY 2009
		SCALE	1:32
			SHEET <b>10 OF 16</b>

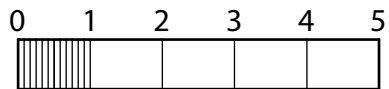
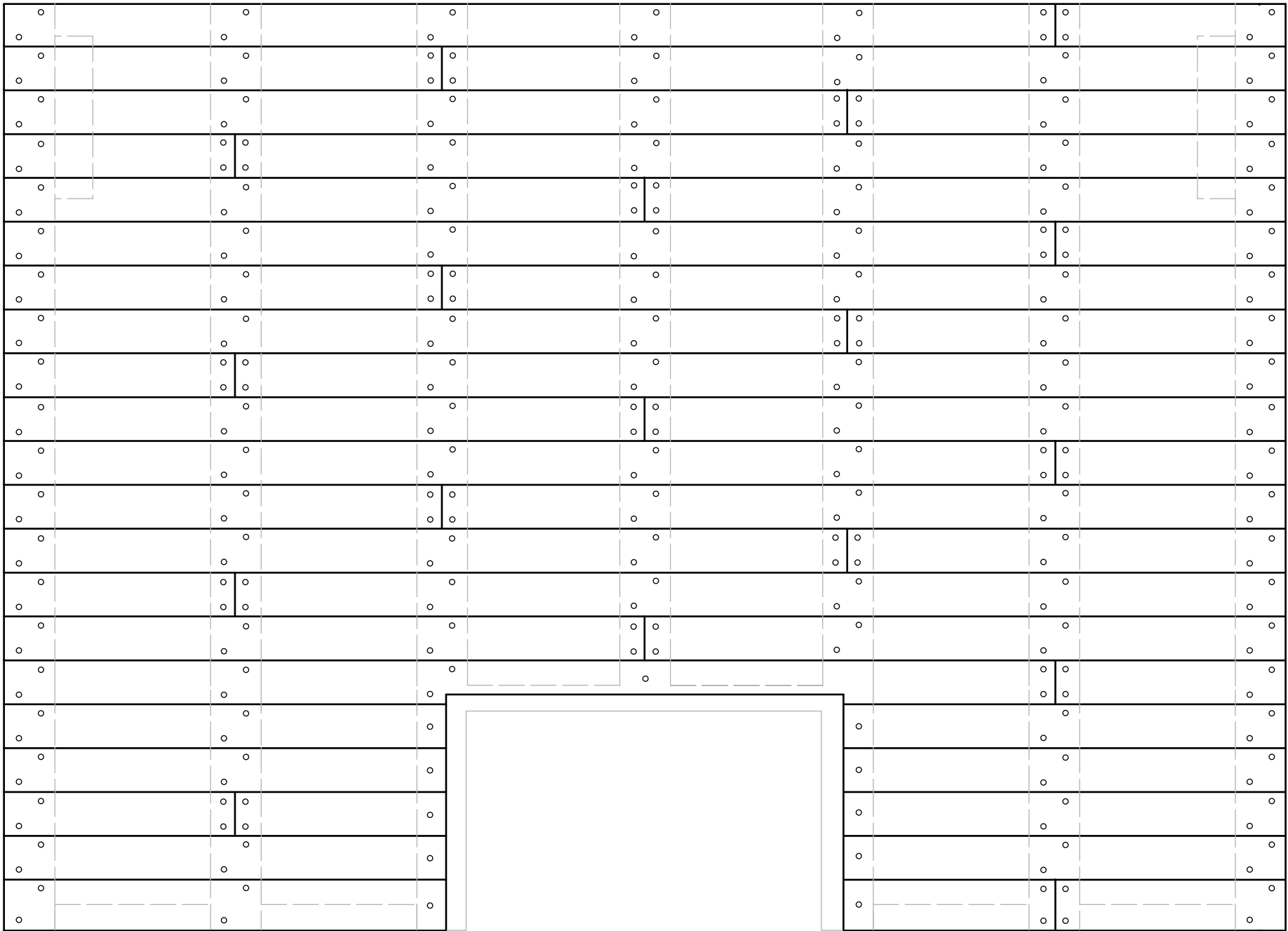

**17th Century Battle Station**

TITLE <b>LOWER DECK PLANKING</b>			SHEET <b>11 OF 16</b>
DRAWN BY JEFF STAUDT	DATE MAY 2009	SCALE 1:32	

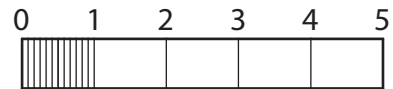
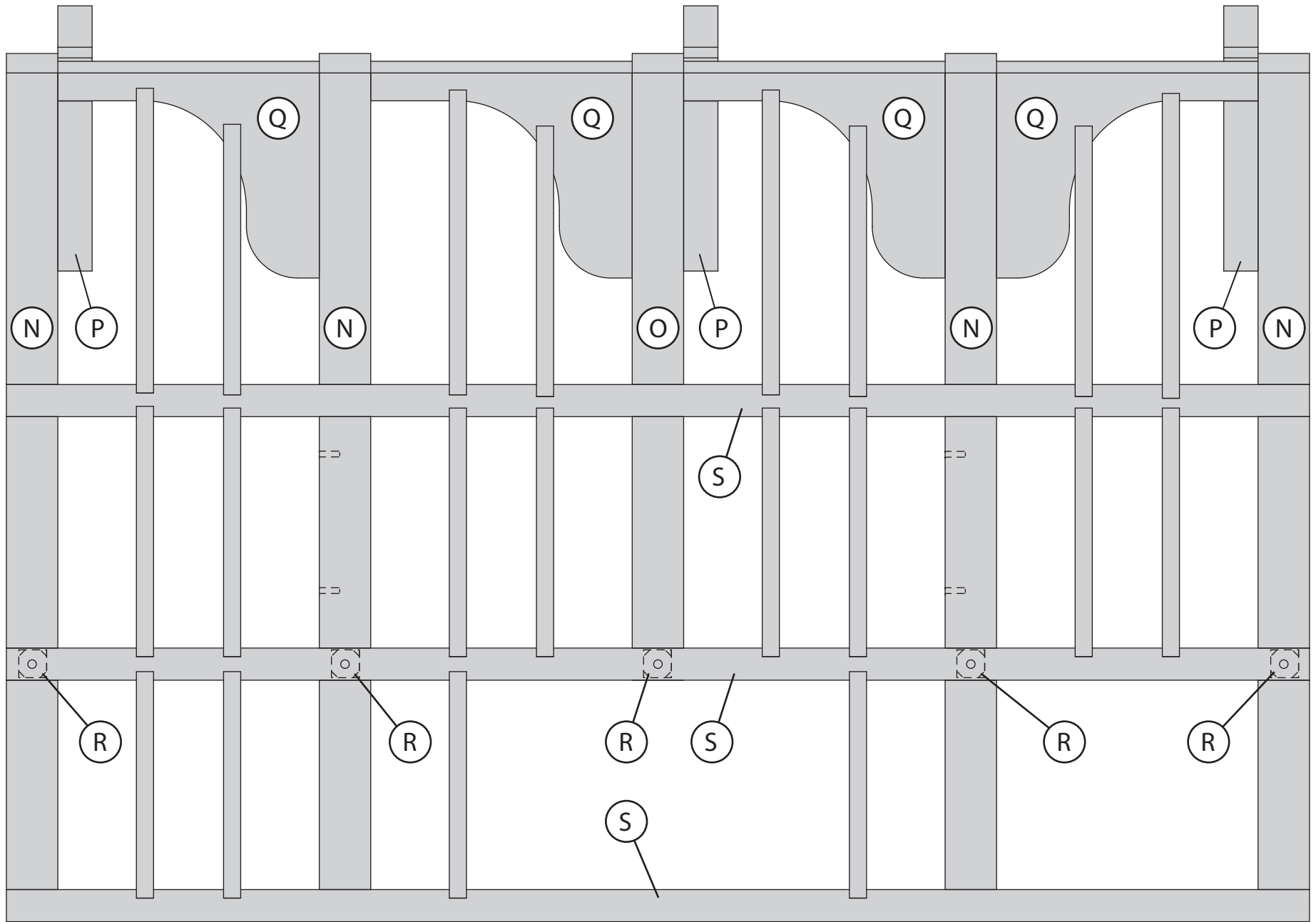

### 17th Century Battle Station

TITLE UPPER DECK FRAMING - TOP VIEW			SHEET <b>12 OF 16</b>
DRAWN BY JEFF STAUDT	DATE MAY 2009	SCALE 1:32	



(S) 3 -Reqd.

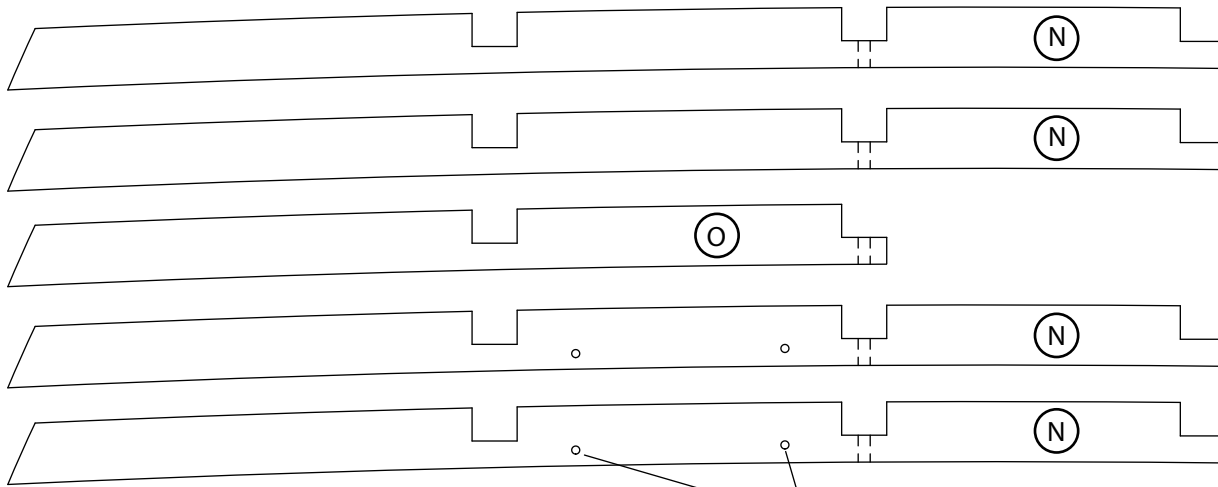

Holes for gunport lid  
block & tackle



(R)  
5 -Reqd.

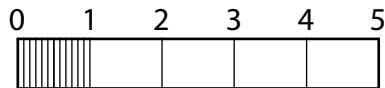
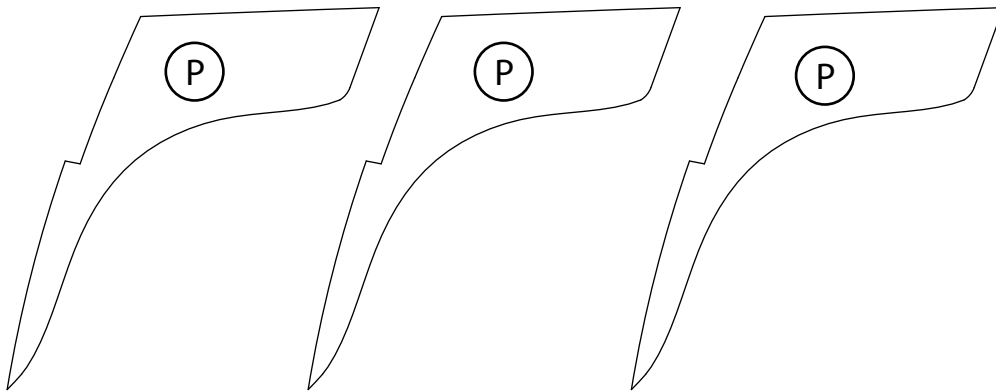
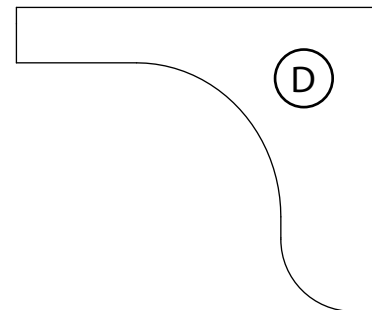
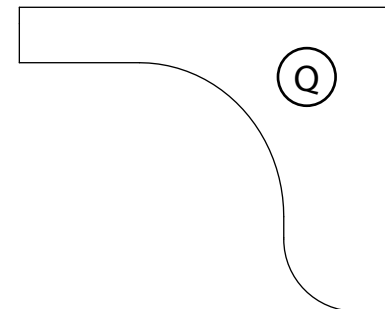
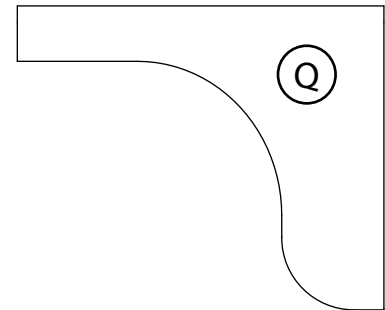
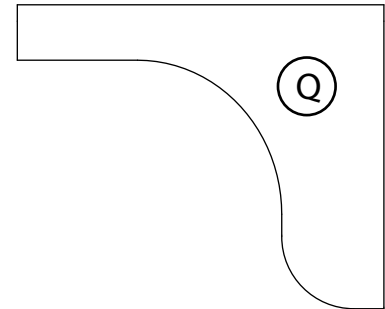

**17th Century Battle Station**

TITLE  
**UPPER DECK PARTS TEMPLATE**

SHEET  
**13 OF 16**

DRAWN BY JEFF STAUDT

DATE MAY 2009

SCALE 1:32

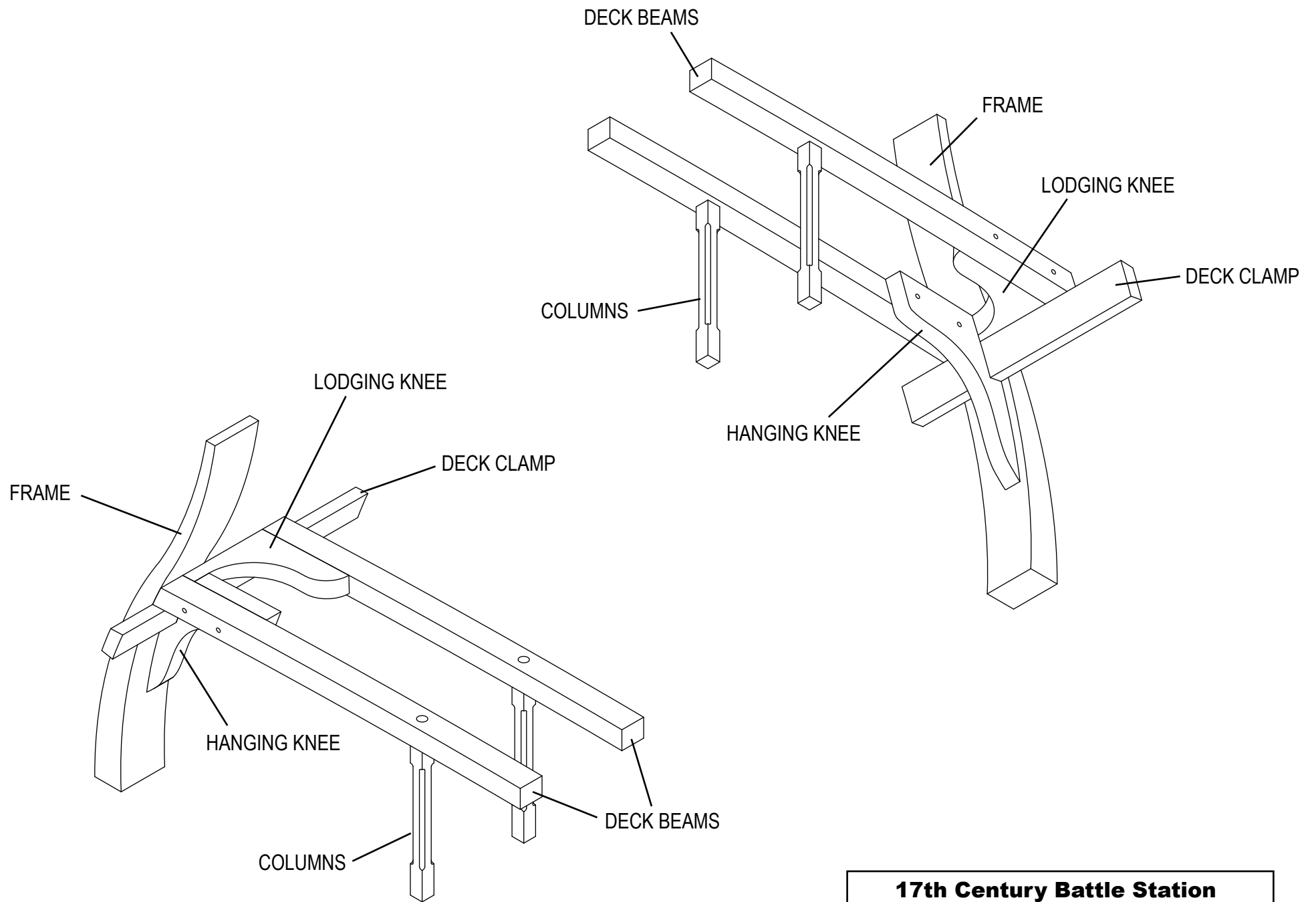

**17th Century Battle Station**

TITLE			SHEET
UPPER DECK FRAMING DETAILS			
DRAWN BY	DATE	SCALE	14 OF 16
JEFF STAUDT	MAY 2009	1:32	

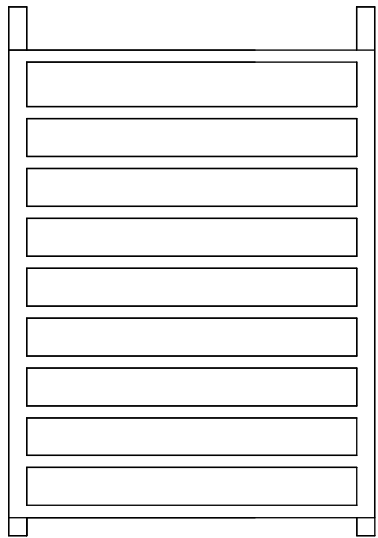

STAIRS

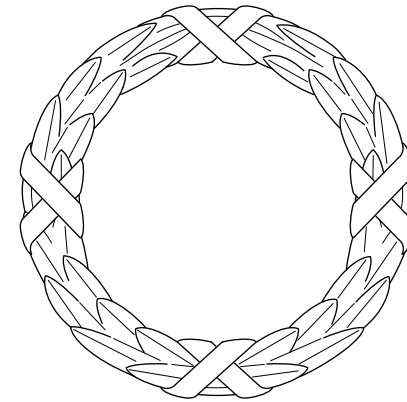
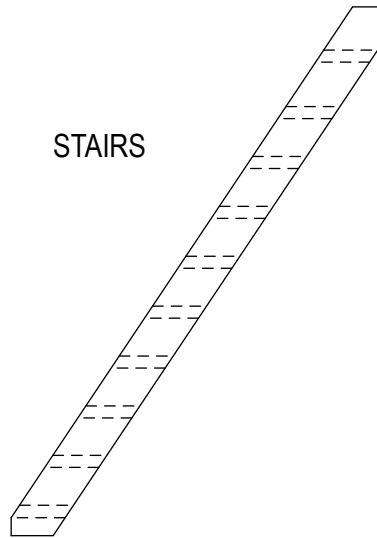

GUNPORT WREATH

LOWER HATCHWAY

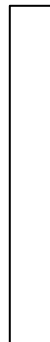
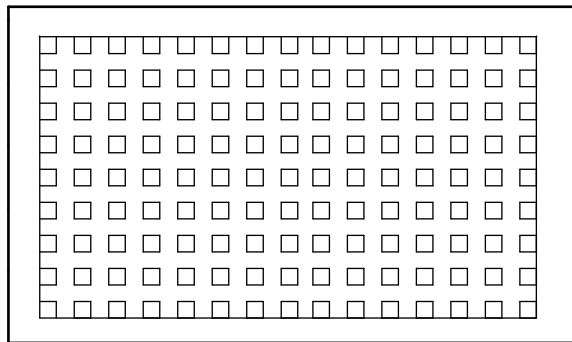

LOWER DECK SHOT RACK



UPPER DECK SHOT RACKS

UPPER HATCHWAY

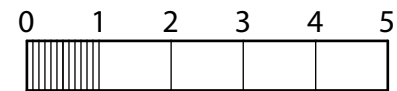
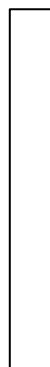
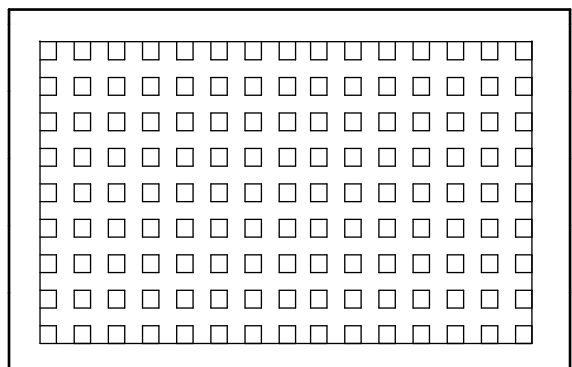

**17th Century Battle Station**

TITLE MISCELLANEOUS DETAILS

SHEET 15 OF 16

© 2009 Navy Board Models.com

DRAWN BY JEFF STAUDT

DATE MAY 2009

SCALE 1:32

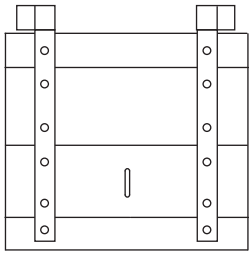

OUTSIDE

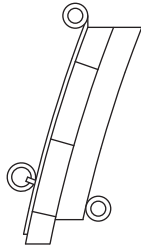

GUNPORT LID

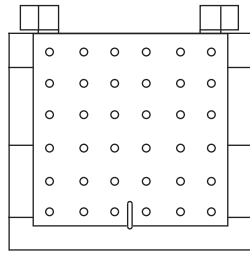

INSIDE

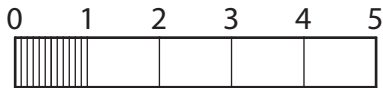
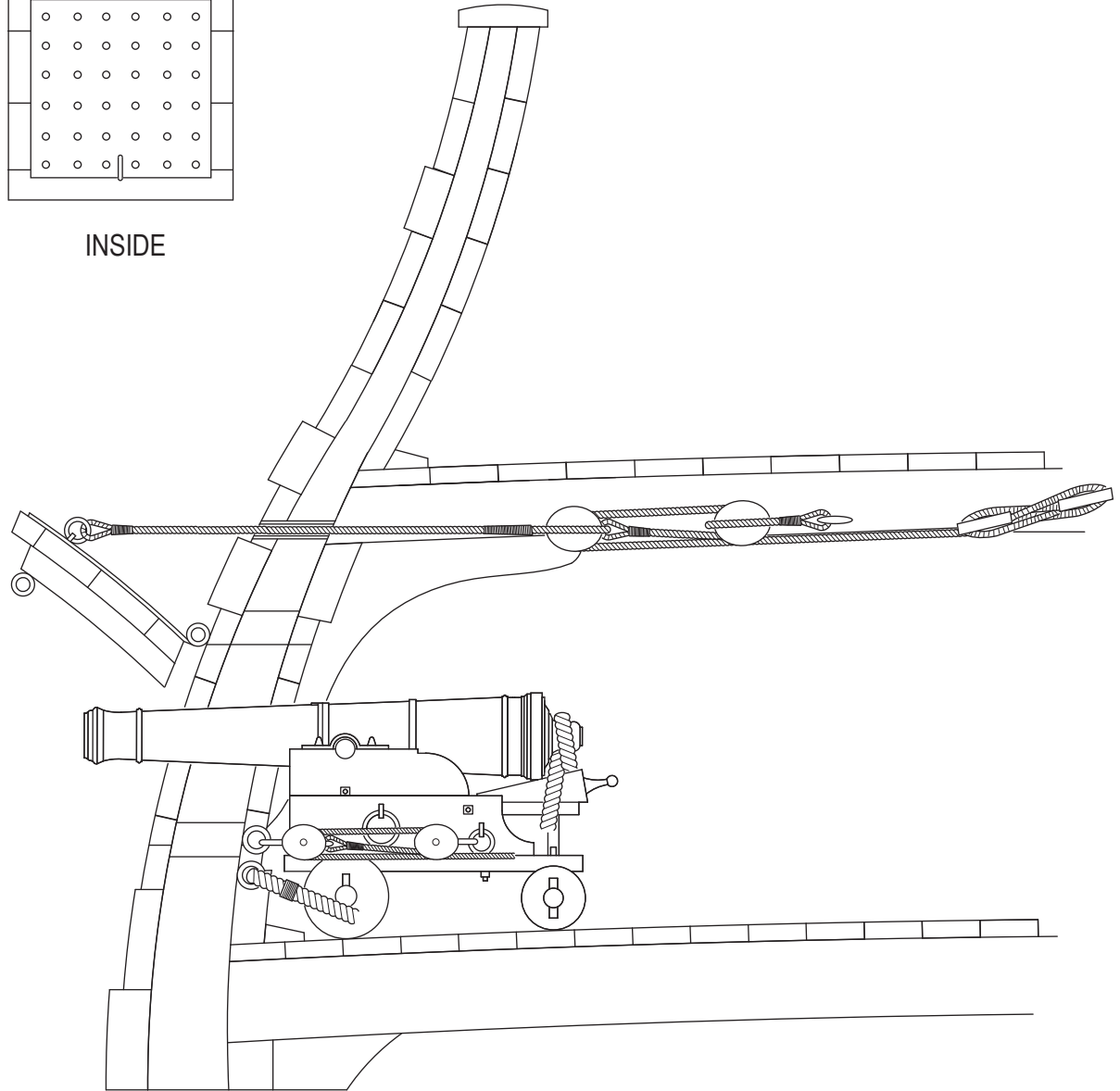

**17th Century Battle Station**

TITLE GUNPORT DETAILS

SHEET

© 2009 Navy Board Models.com

DRAWN BY JEFF STAUDT

DATE MAY 2009

SCALE 1:32

16 OF 16

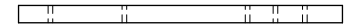
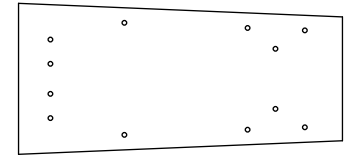
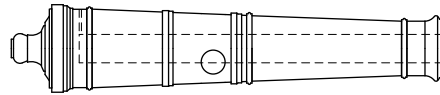
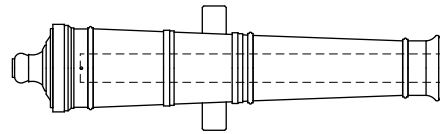
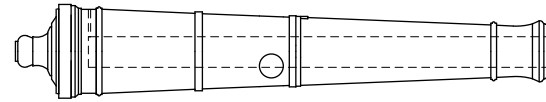
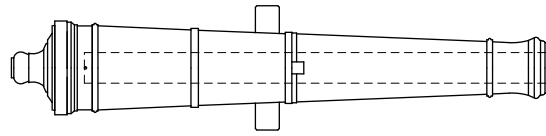
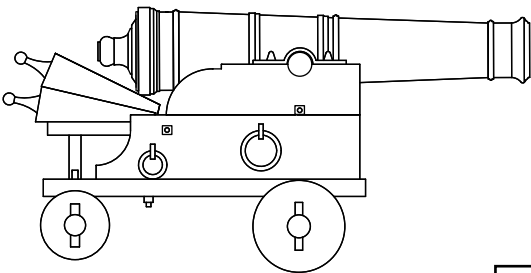
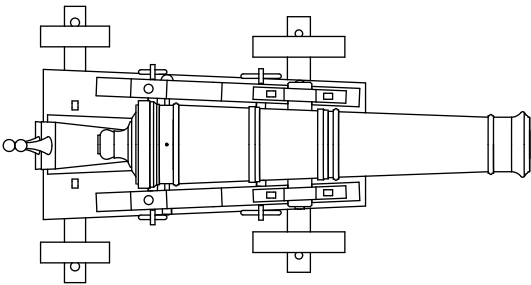
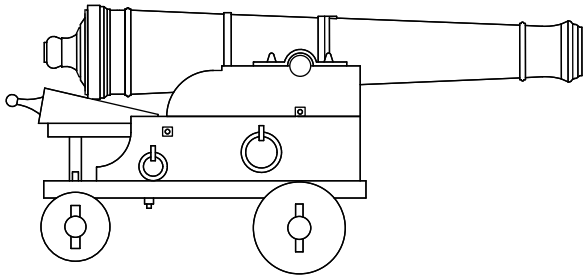
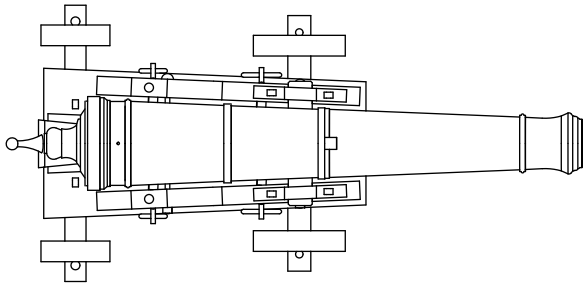

1



2



3

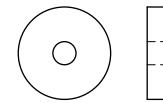

4

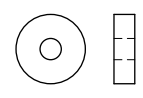

5

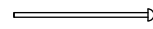

A



B

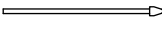

C - Qty (4)

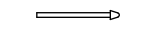

D - Qty (4)

F - Qty (4)

E - Qty (16)

G - Qty (2)

I - Qty (2)

J - Qty (2)

H - Qty (2)

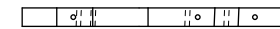
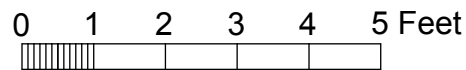

6



7

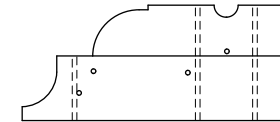

8



9



10

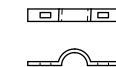

11 Qty (2)

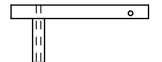

11

### English Sea Ordnance

TITLE GUN DETAILS

SHEET 1 OF 2

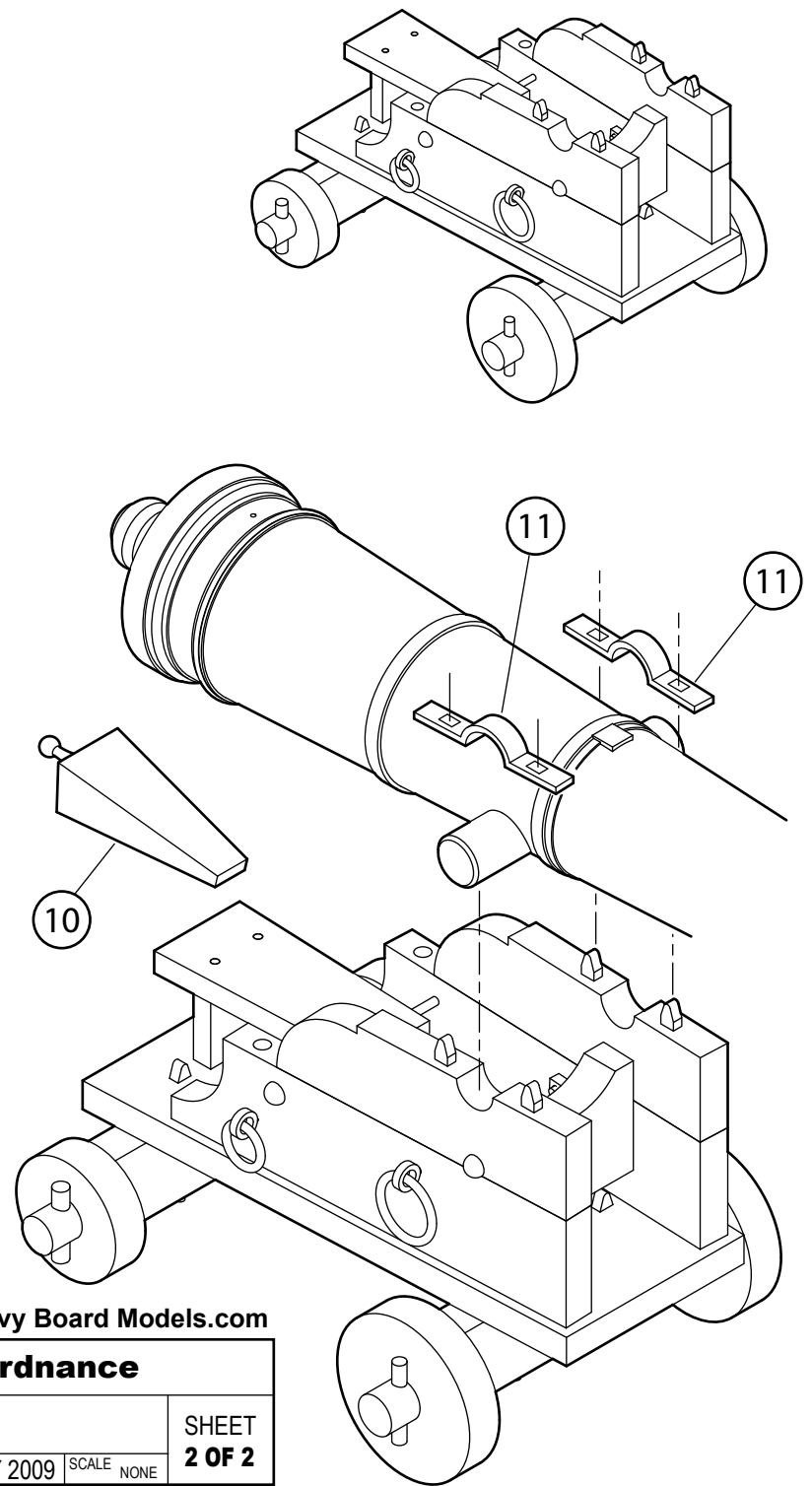
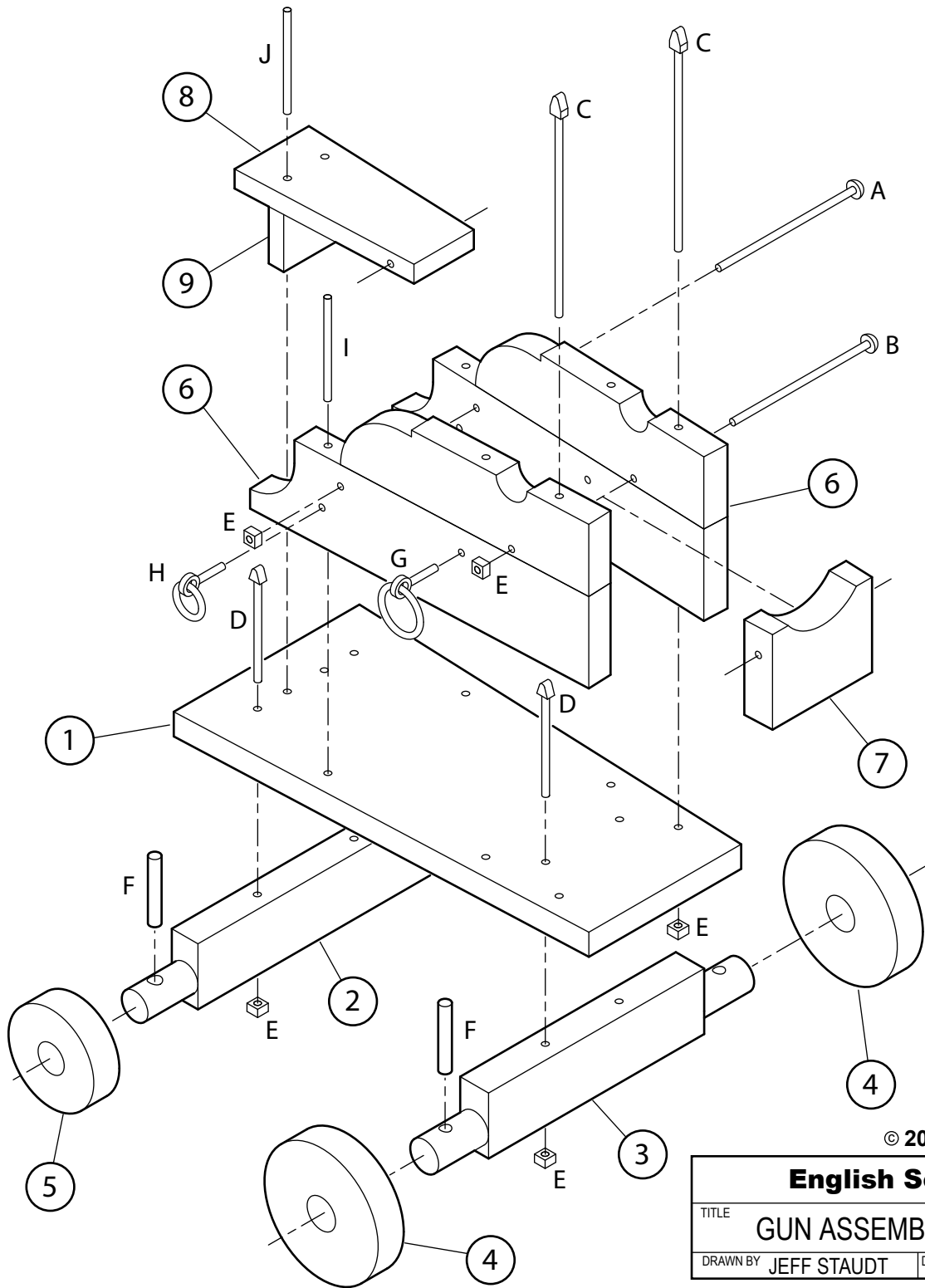

© 2009 Navy Board Models.com

<b>English Sea Ordnance</b>		
TITLE	GUN ASSEMBLY	
DRAWN BY	DATE	SCALE
JEFF STAUDT	MAY 2009	NONE
		SHEET <b>2 OF 2</b>